

Document suivant en grande taille

Format d'origine A1 -> 840 x 594 mm

pages suivantes :

Document

Réduit en 1 page A3



Redécoupé en 4 pages A3 successives

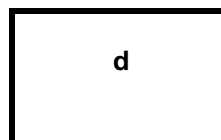
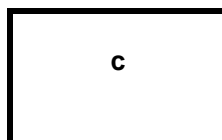
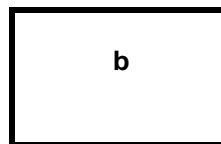
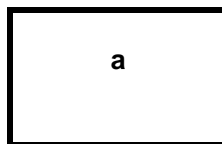

permettant la recomposition du document en taille réelle

NOM :
PRENOM :
NUMERO :

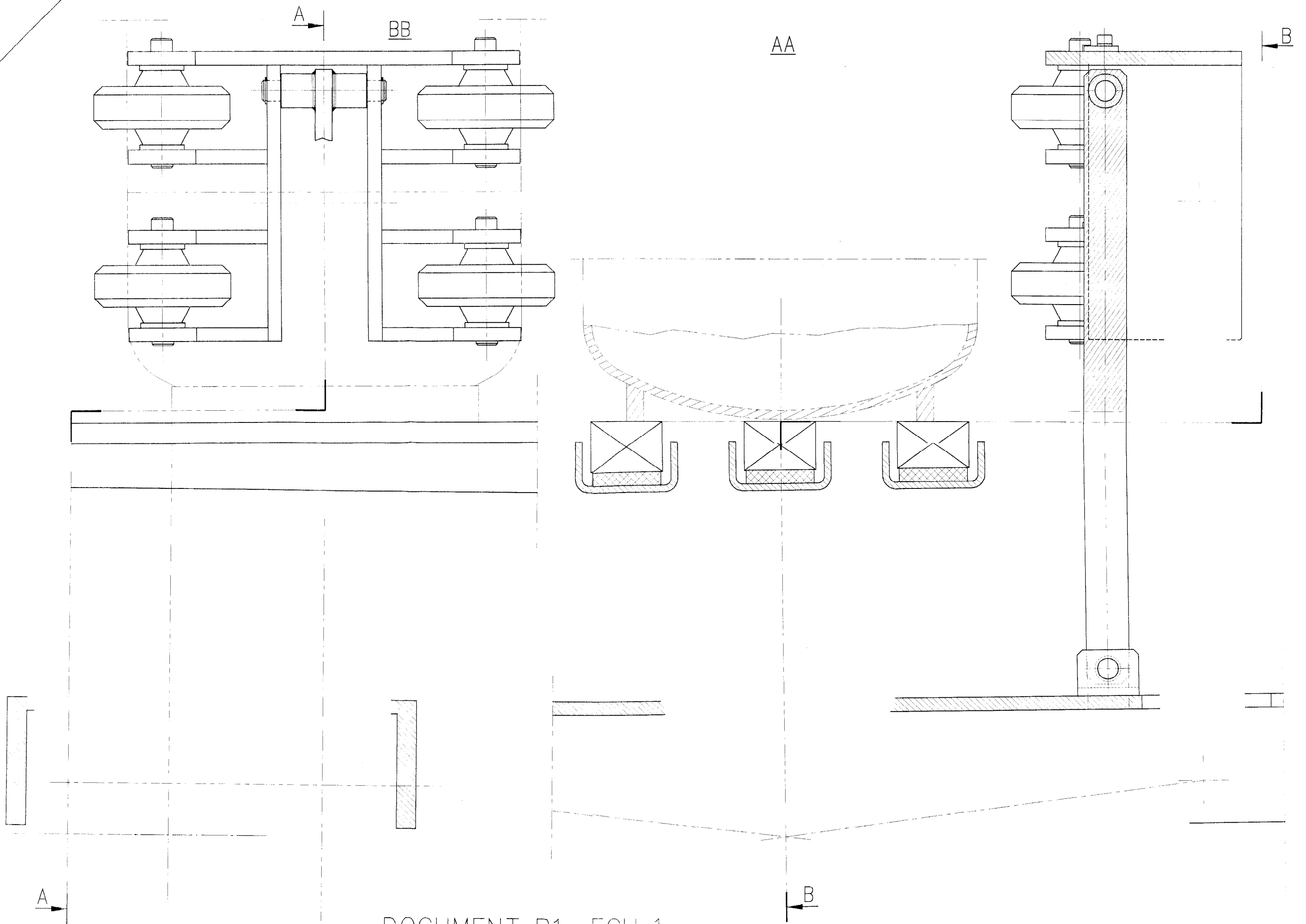

DOCUMENT R1 ECH: 1

NOM :
PRENOM :
NUMERO :

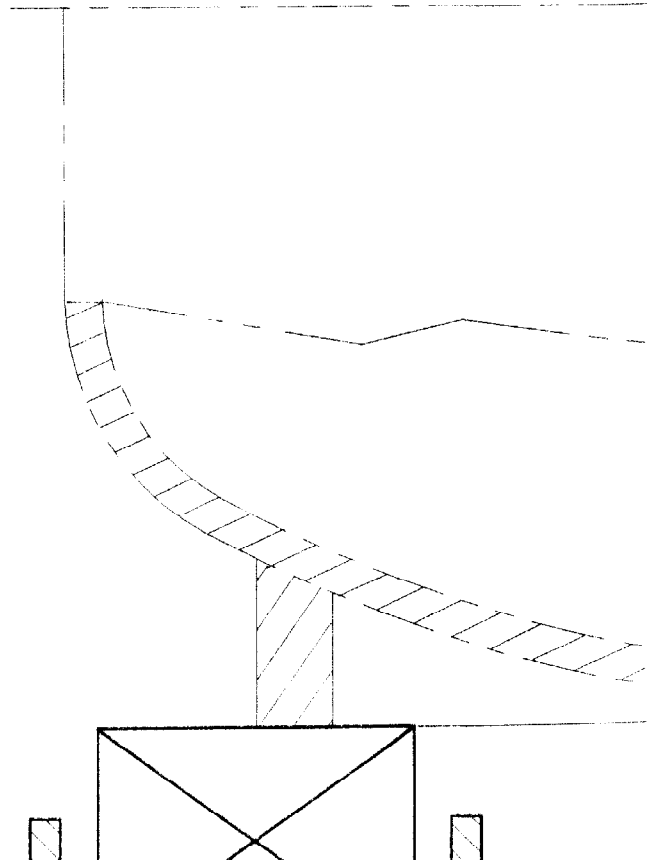
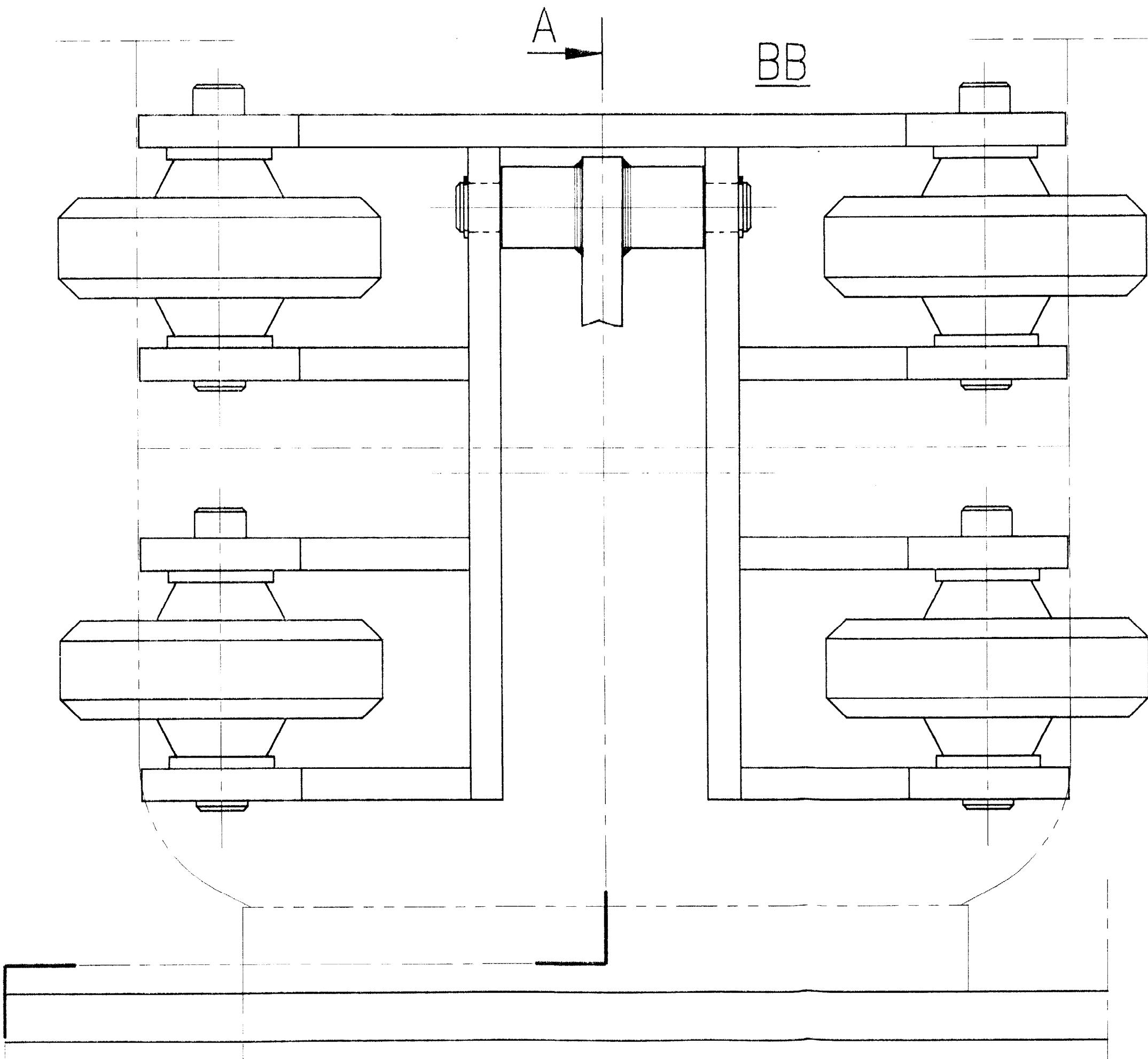

AA

B

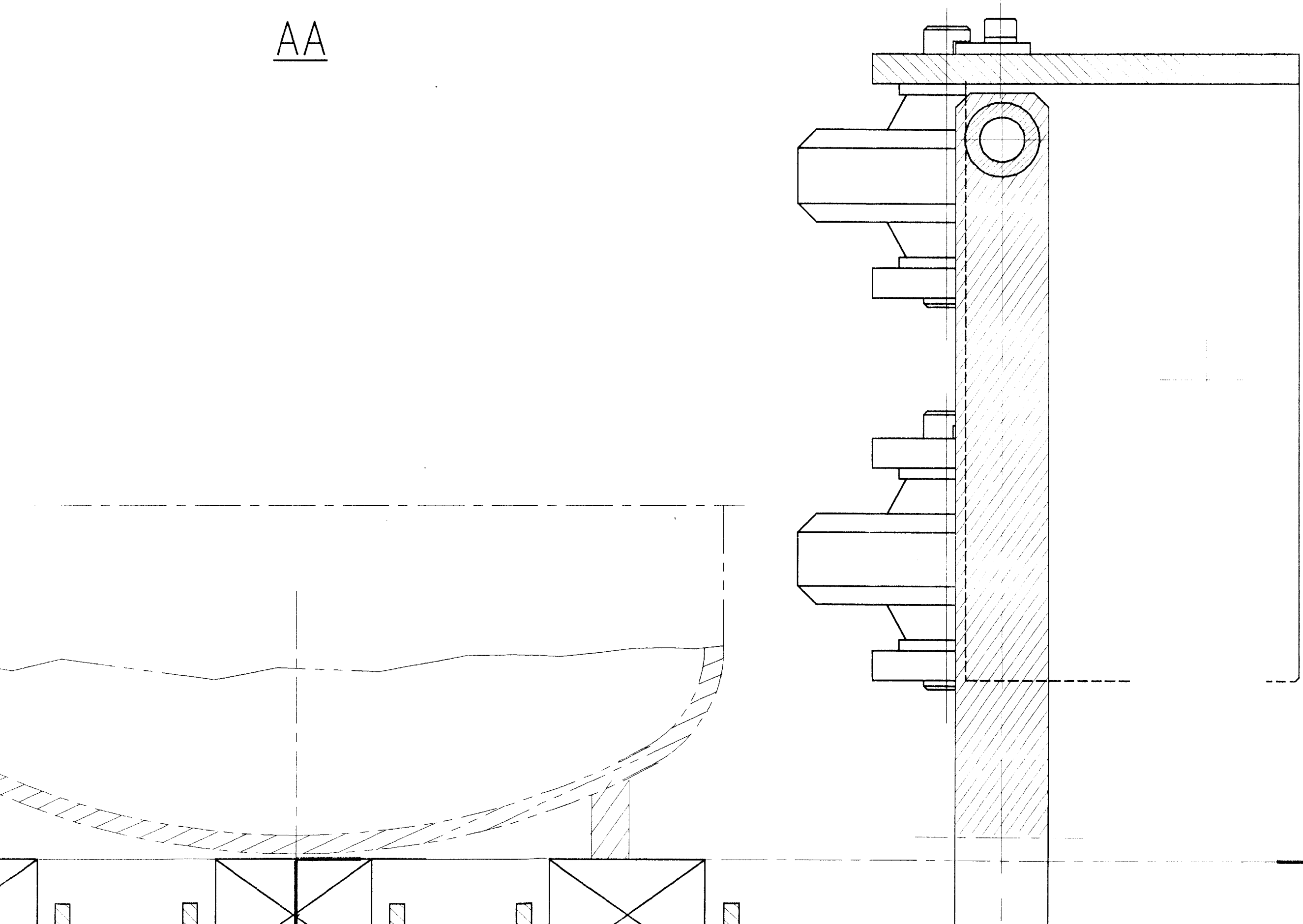

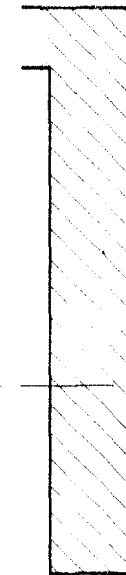
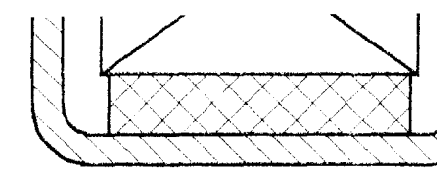

A →

DOCUMENT R1 ECH: 1

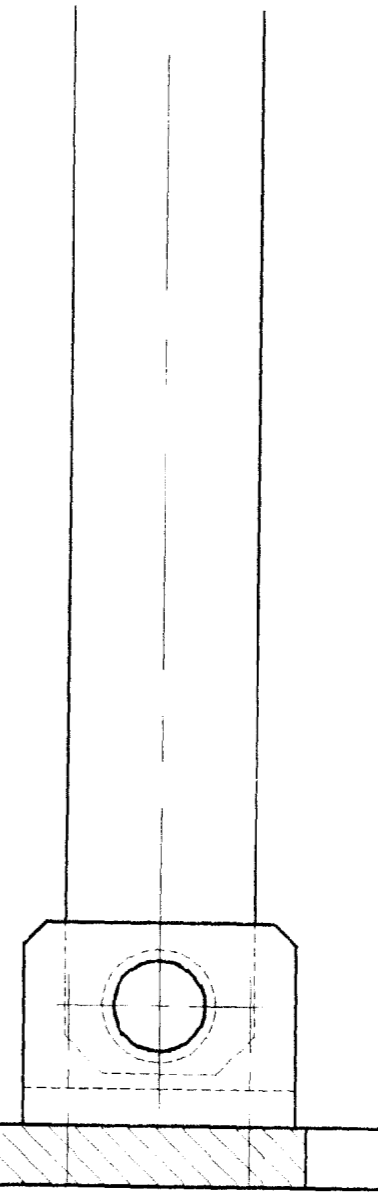
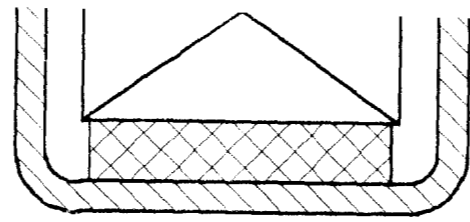
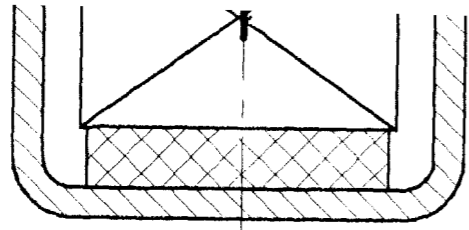
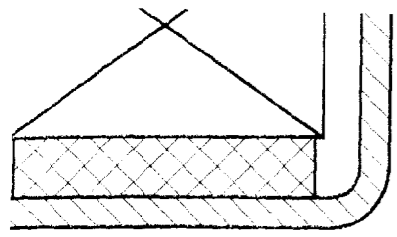

B

ECH: 1

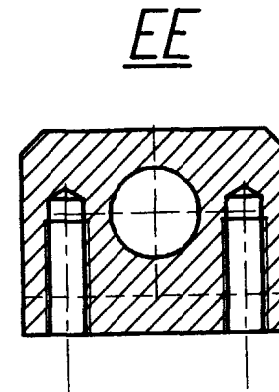
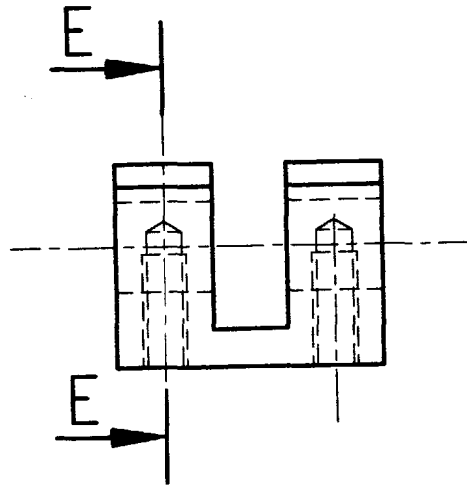
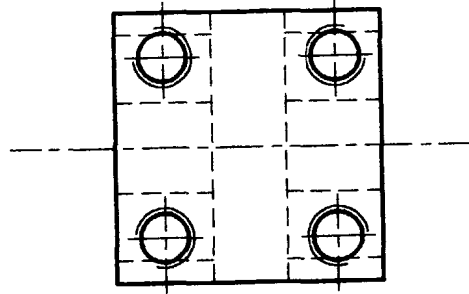

NUMERO:

PRENOM:

NOM:

DOCUMENT R2

Ech. 1:1