

**Nomenclature**

**Carte système minimum à 6809**

Fournisseur : EURO-COMPOSANTS  
4, route nationale BP13  
08110 BLAGNY

Réf	Désignation	Qté	Repères	Prix/u (F)
02005	6821P PIA 1MHz	1	IC1	32,00
02003	6809P Microprocesseur 8/16 bits	1	IC2	48,00
02077	27C64 8*8K 200ns Uprogram 12,5V	1	IC3	22,00
02060	6264P 8*8K 150ns statique	1	IC4	29,00
74LS138	Décodeur / démultiplexeur	1	IC5	3,50
08179	Support 40 broches	2	IC1, IC2	6,50
08173	Support 16 broches	1	IC5	2,70
08178	Support 28 broches	2	IC3, IC4	4,80
08054	Connecteur HE10 Coudé	1	XA1	12,50
08090	SC-02 Borniers à vis	1	X	2,00
08001	MH-190 Connecteur sécable 90°	2	XA2, XA3	6,90
04040*	Résistance 2,2kΩ 1/4W	6	R1, R2, R3, R4, R5, R6	0,10
04935	Condensateur 100μF 25V	1	C1	0,80
04908	Condensateur 4,7μF 50V	1	C2	0,50
04817	Condensateur 100nF	4	C3, C4, C5, C6	1,00
04713	Condensateur 22pF	2	C7, C8	0,50
05237	Quartz 4,0MHz	1	Q1	5,00
07130	Bouton poussoir D6C-R	1	S	4,20

(\*) Prix par 10.

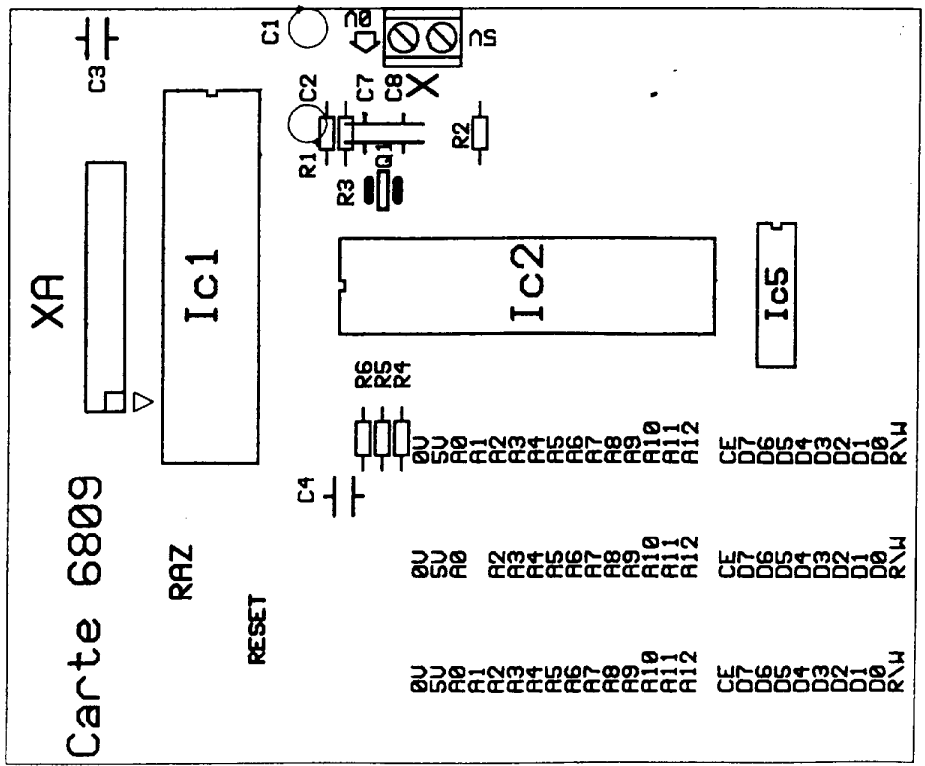
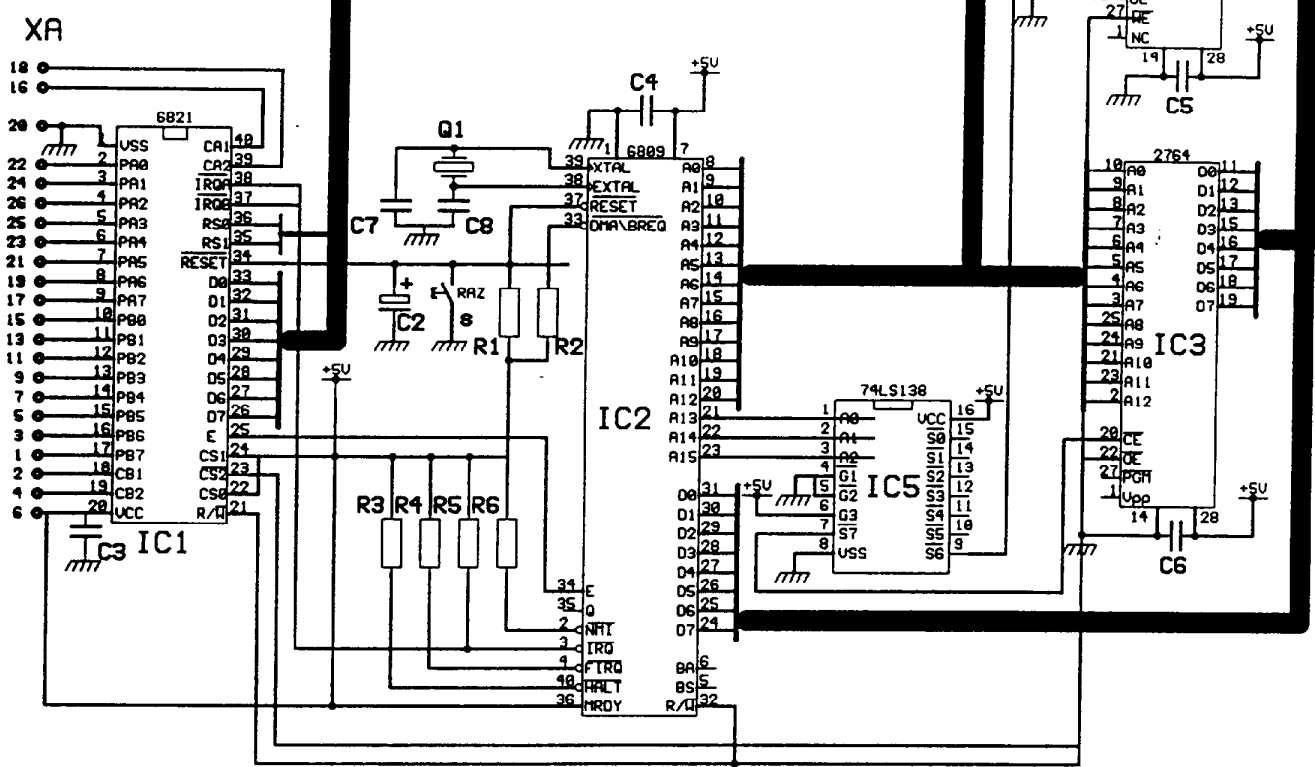
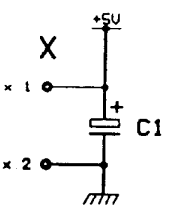

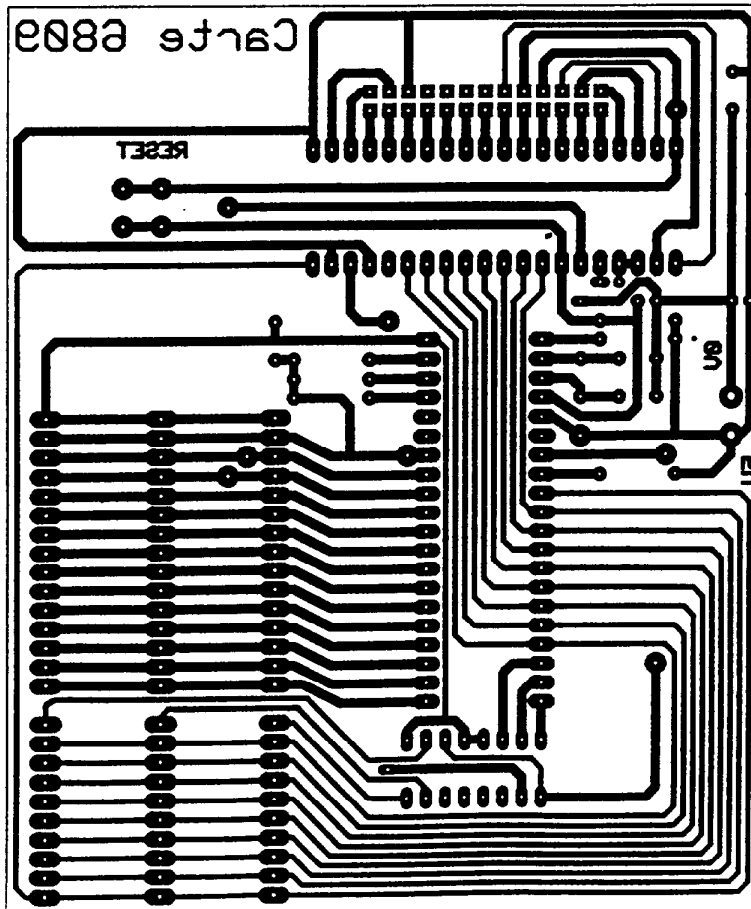
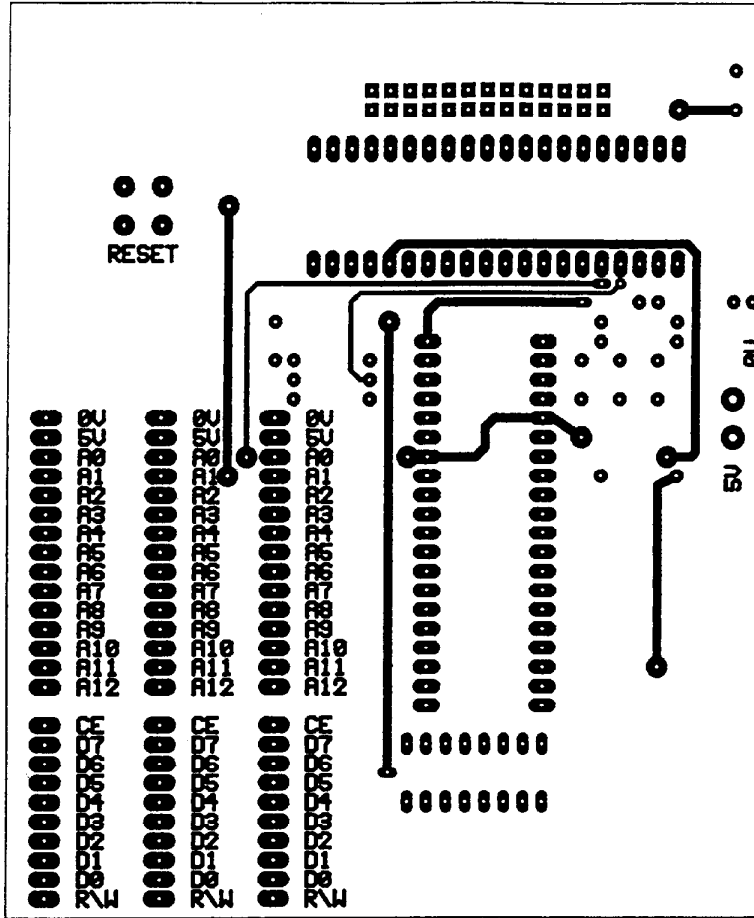

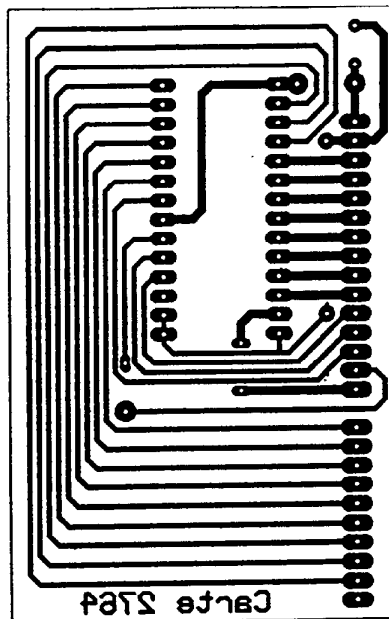
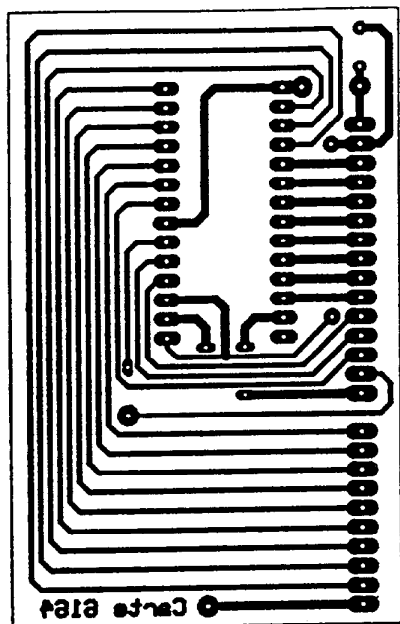

### Module récepteur.

Fournisseur: CONRAD Electronique  
VEPEX 5000  
59861 Lille CEDEX 9

Réf	Désignation	Qté	Repères	Prix/u (F)
0190691-11	Récepteur DCF77	1		95,00
0535630-11	Antenne spéciale DCF77	1		12,00

