

DOSSIER DOCUMENT REPONSE

Ce dossier comporte le document réponse DR1 en deux exemplaires dont un seul est à rendre :

DR1 : plan partiel échelle 1

DR1

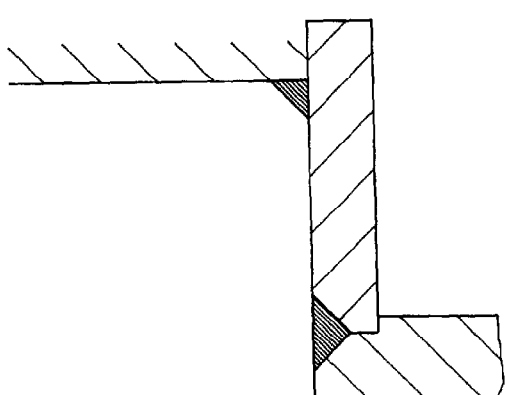
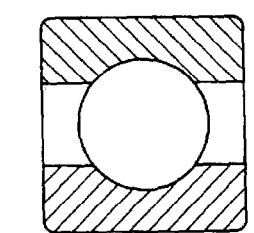
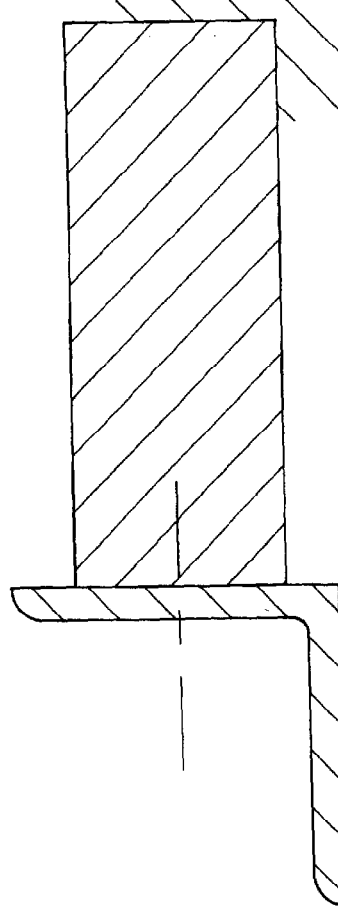
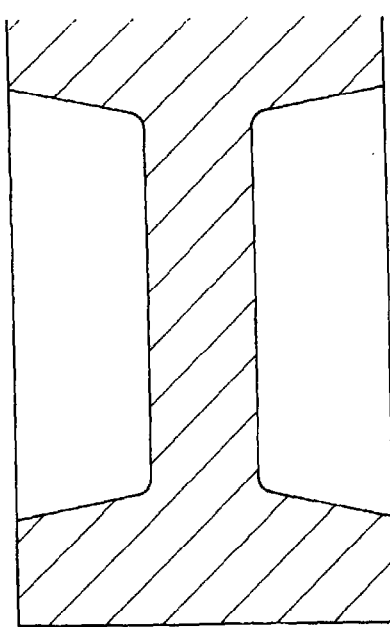
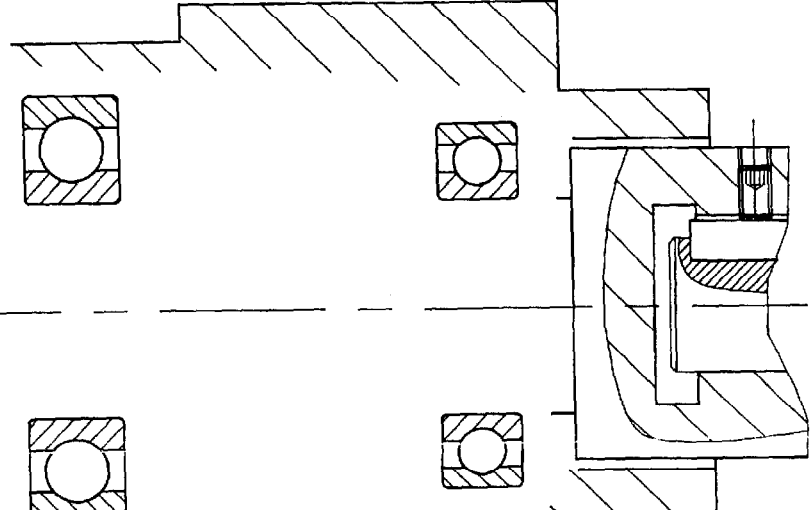
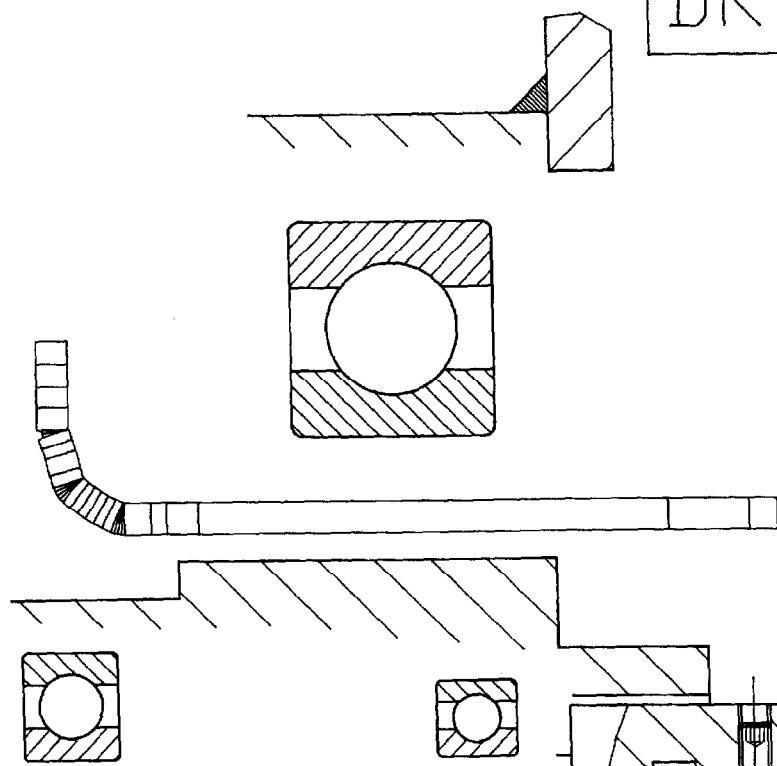
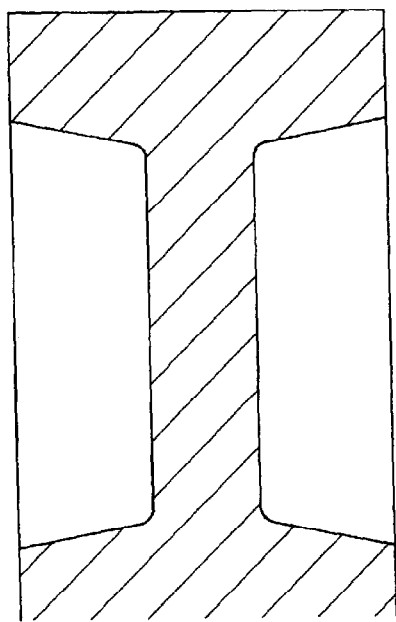

Echelle 1:1