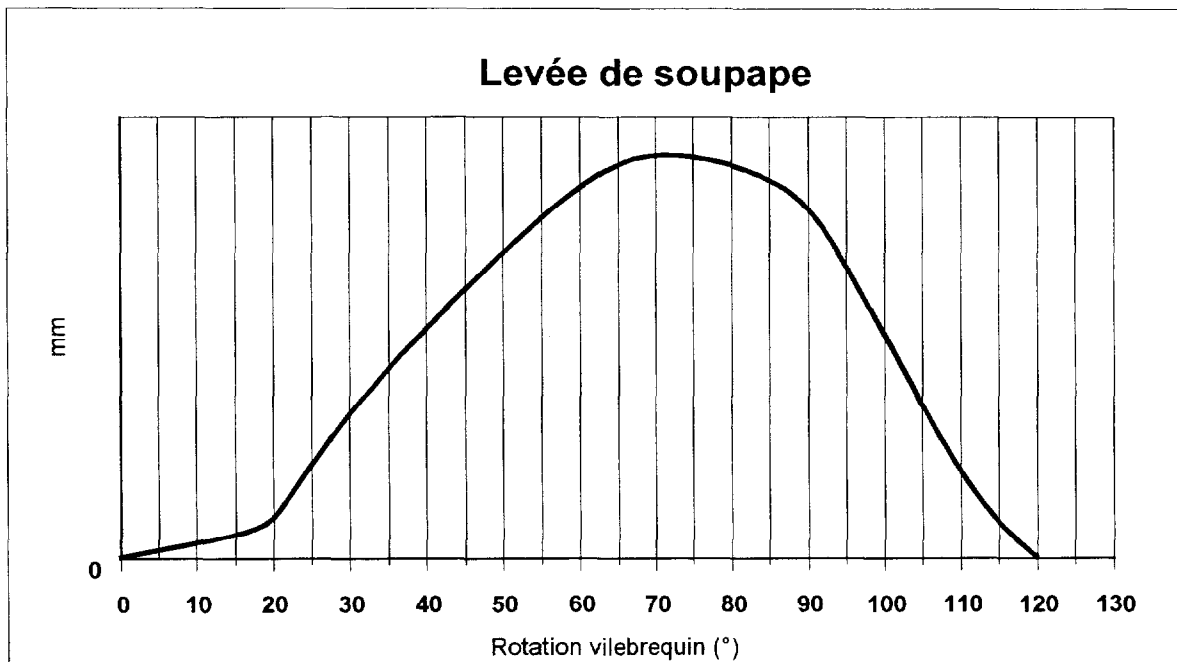




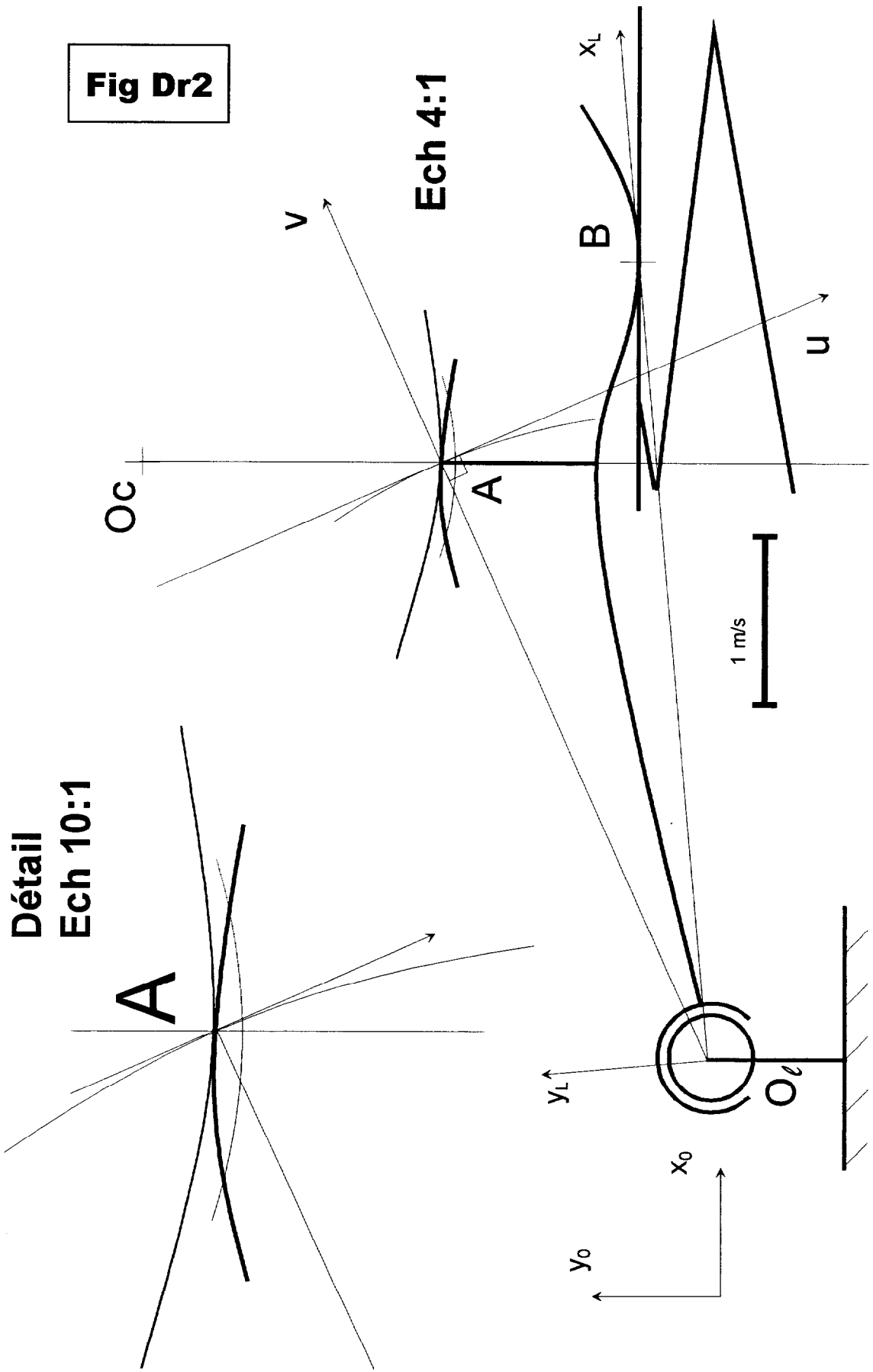
## **DOSSIER DES DOCUMENTS "RÉPONSE"**

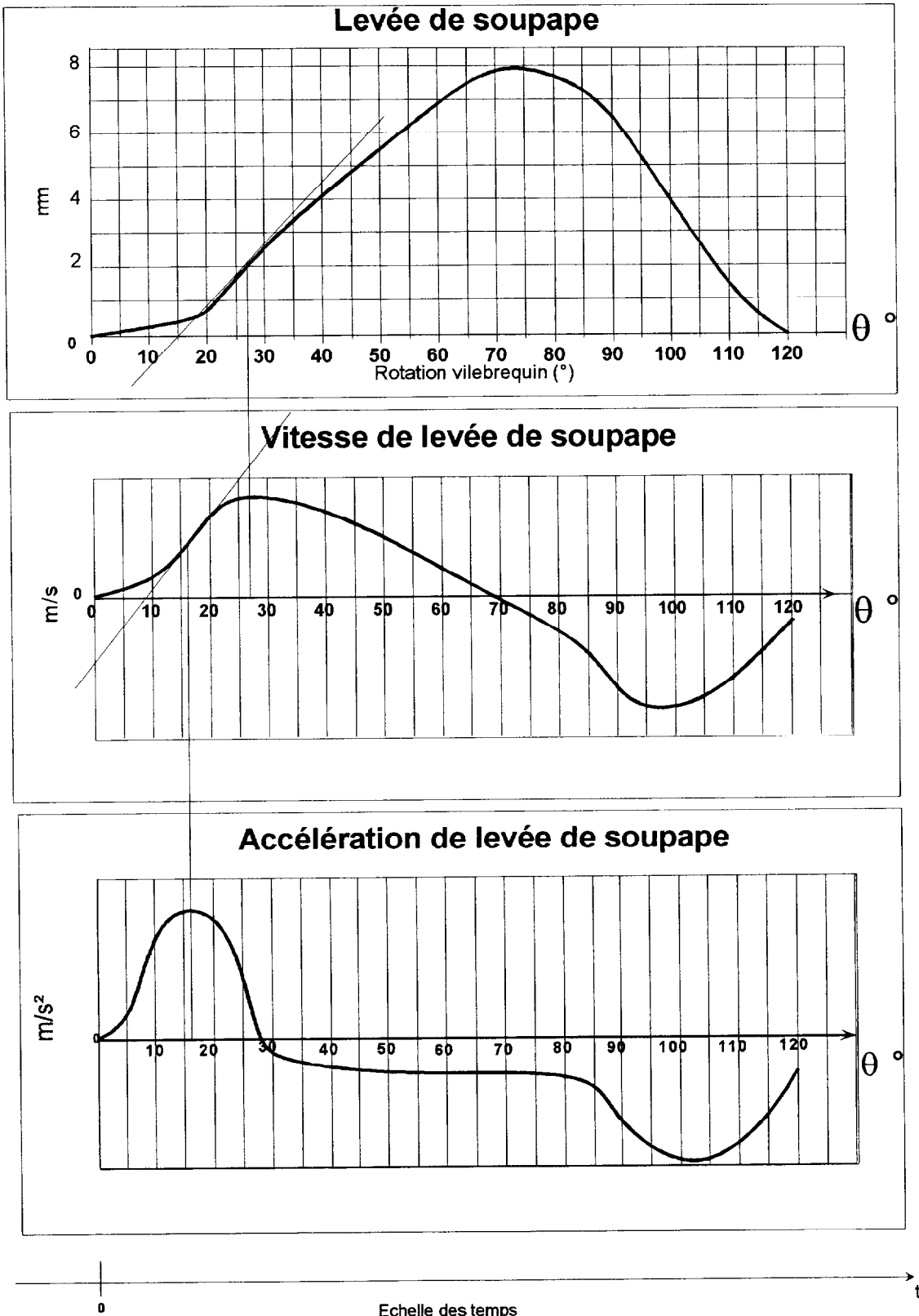
Ce dossier comporte 8 documents numérotés Dr 1 à Dr 8.

**Ces documents sont à joindre à la copie en fin d'épreuve.**

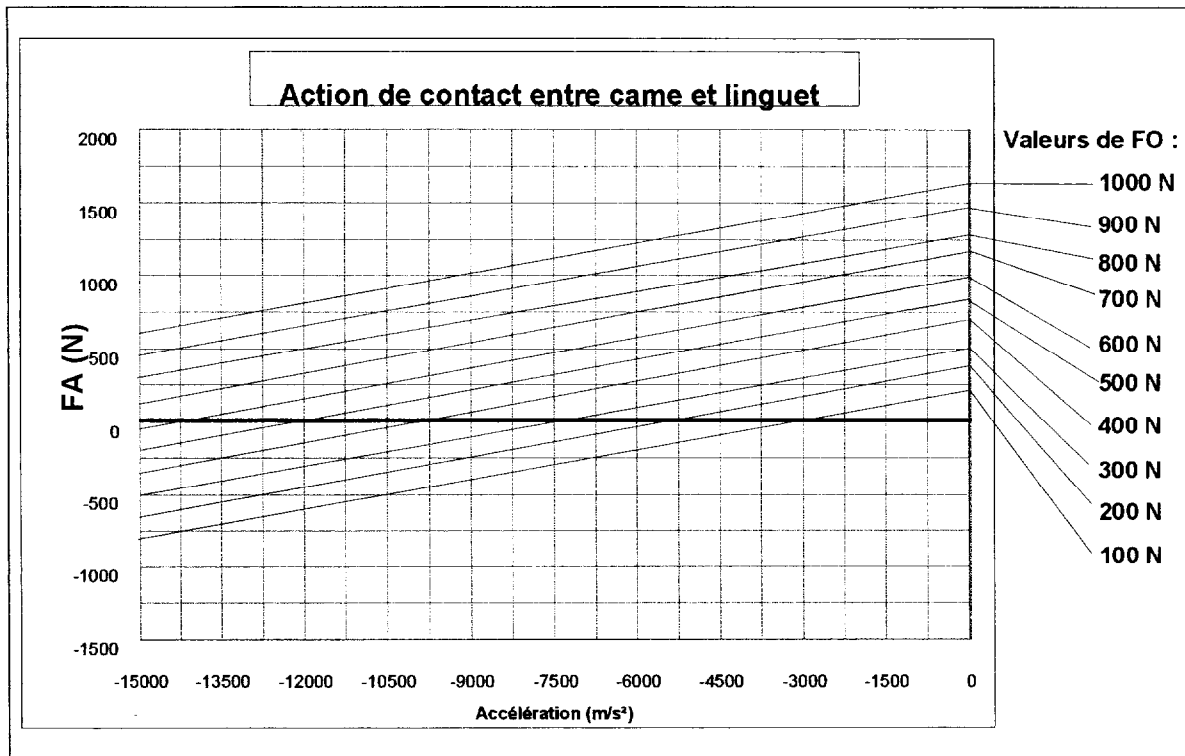


**Fig. Dr 1**

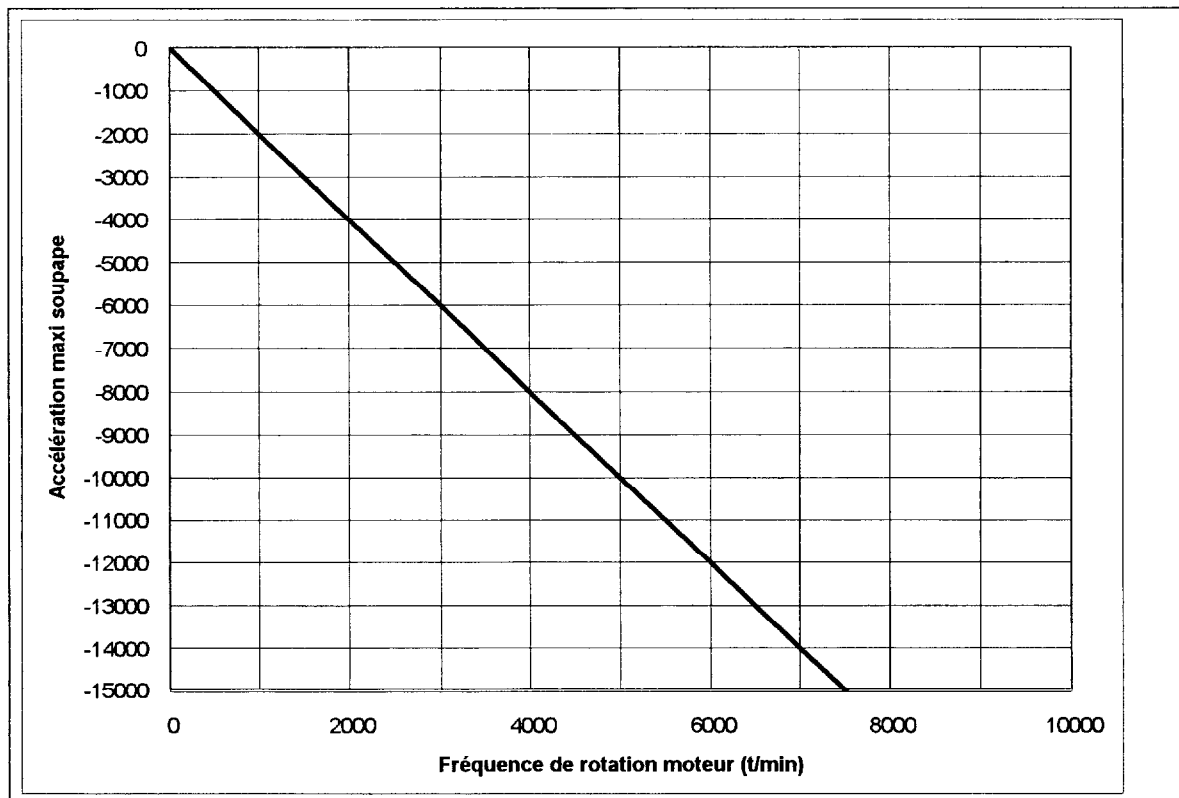




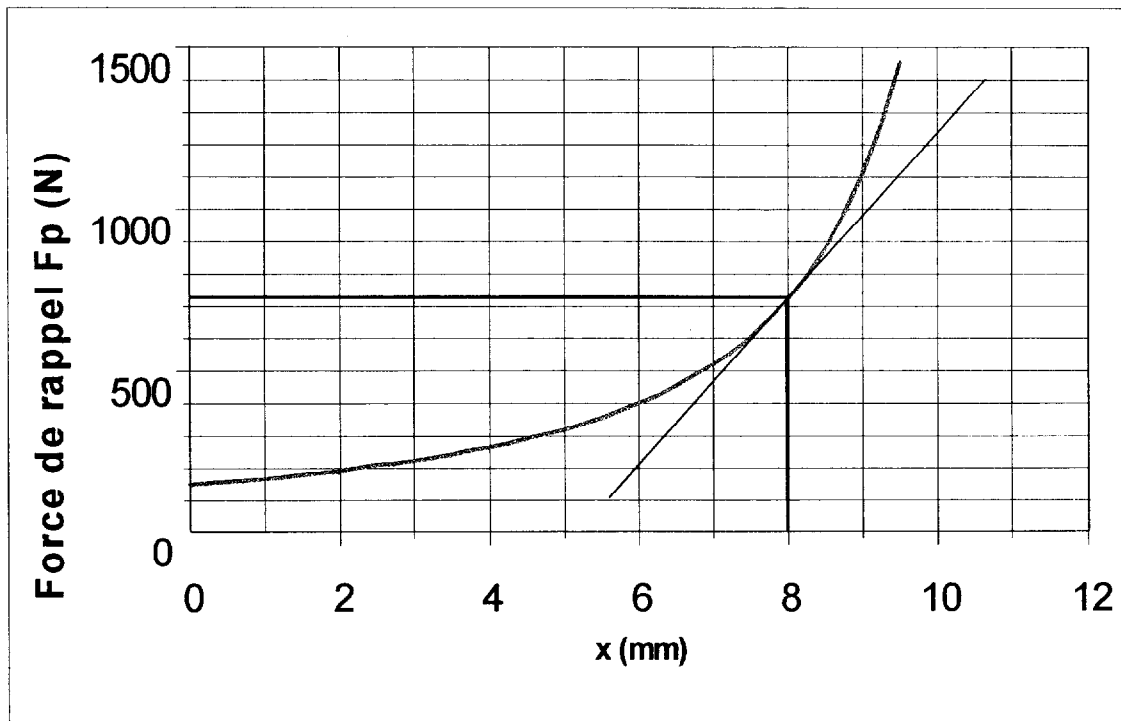
**Fig. Dr 3**



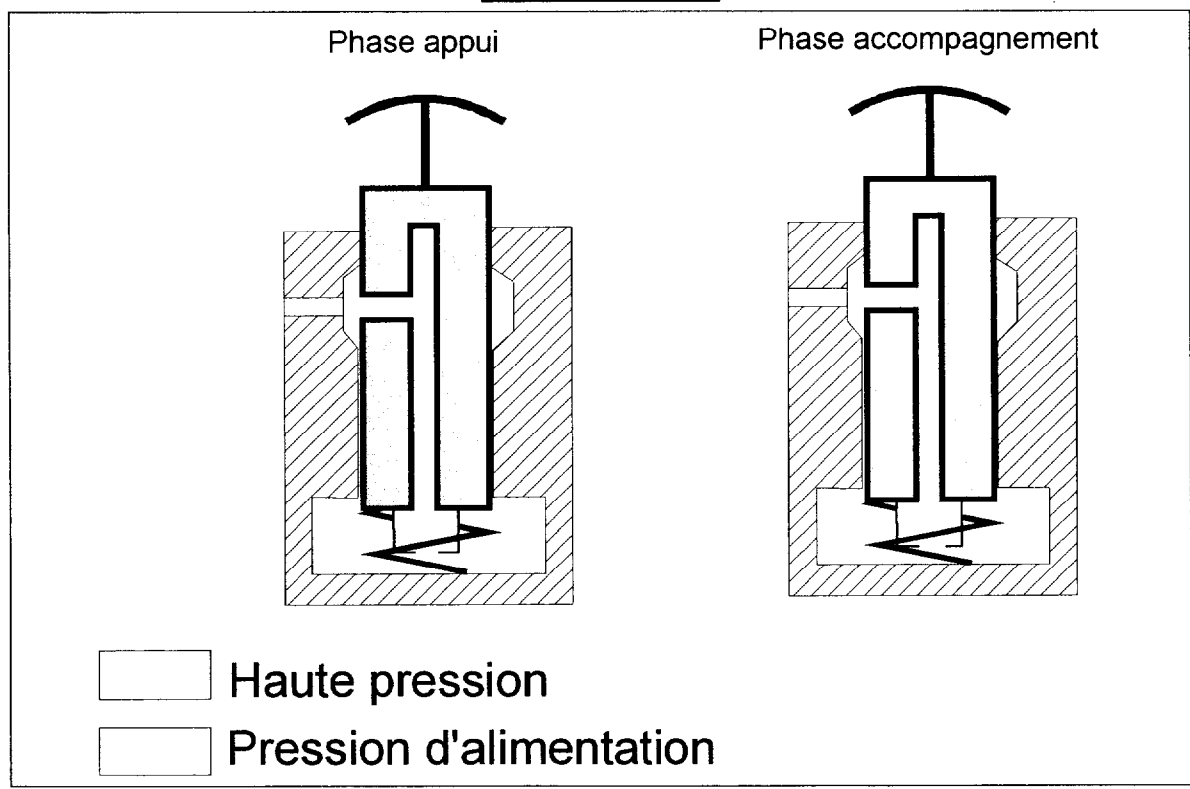
**Fig Dr 4**



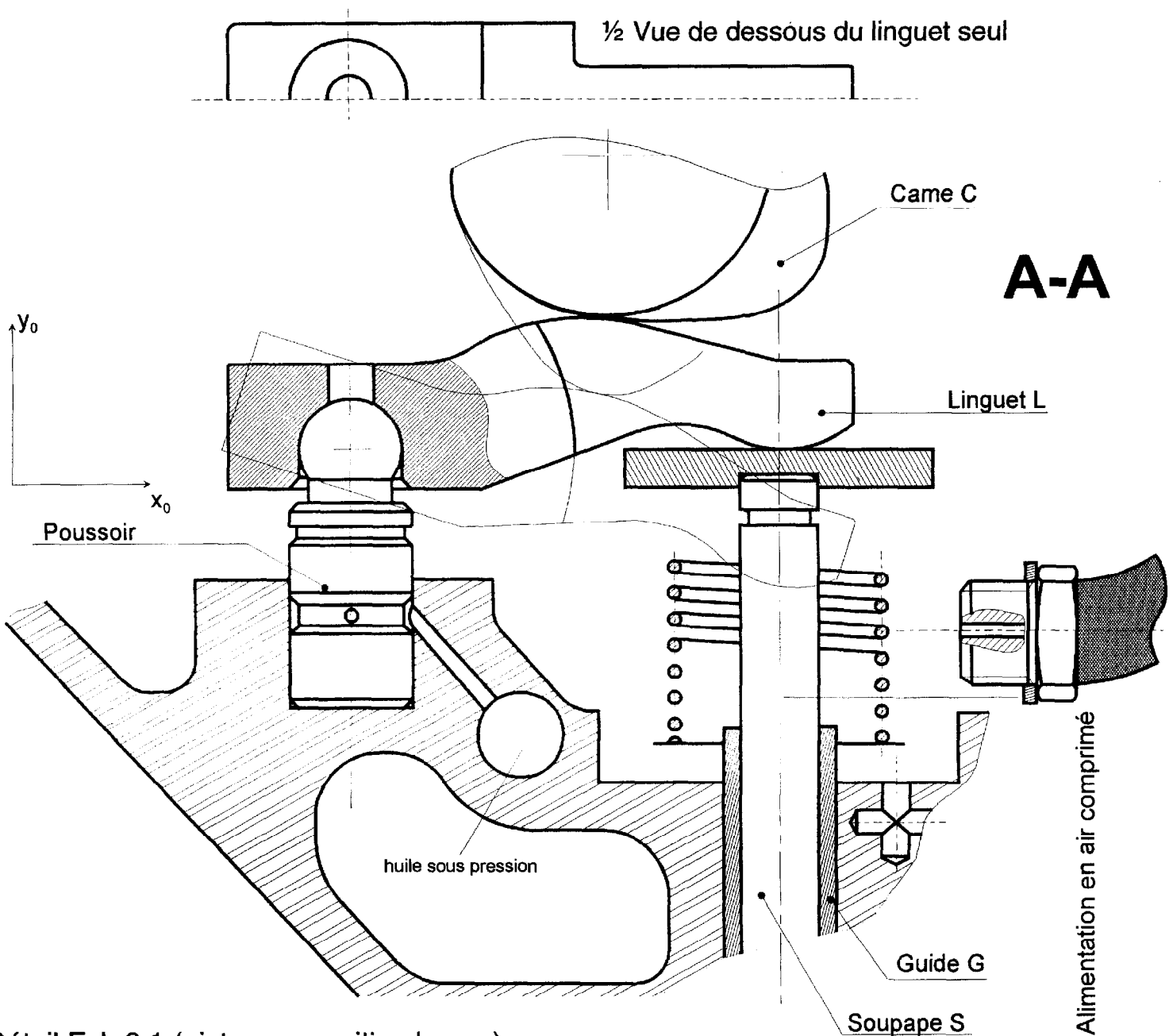
**Fig Dr 5**



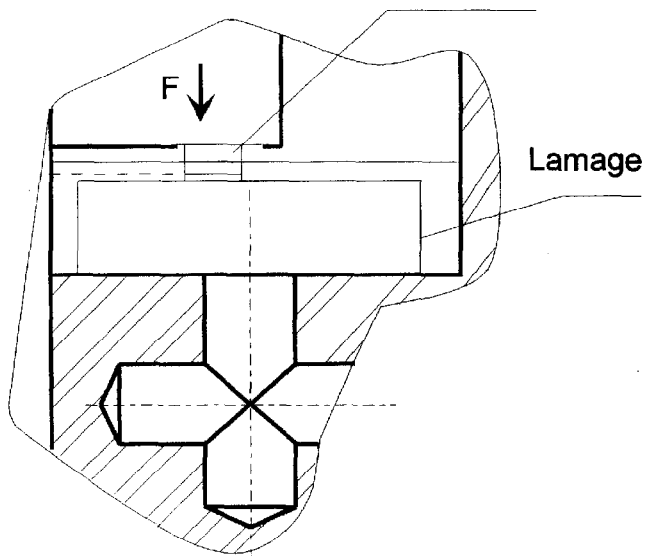
**Fig. Dr 6**



**Fig. Dr 7**



Détail Ech 8:1 (piston en position basse)  
Rainure circulaire



Détail vue F

Rondelles élastiques



1/2 Vue de dessus du cylindre seul

## Ressort pneumatique Ech 3:1

**Fig Dr 8**