

PLAN D'IMPLANTATION G1 à G6

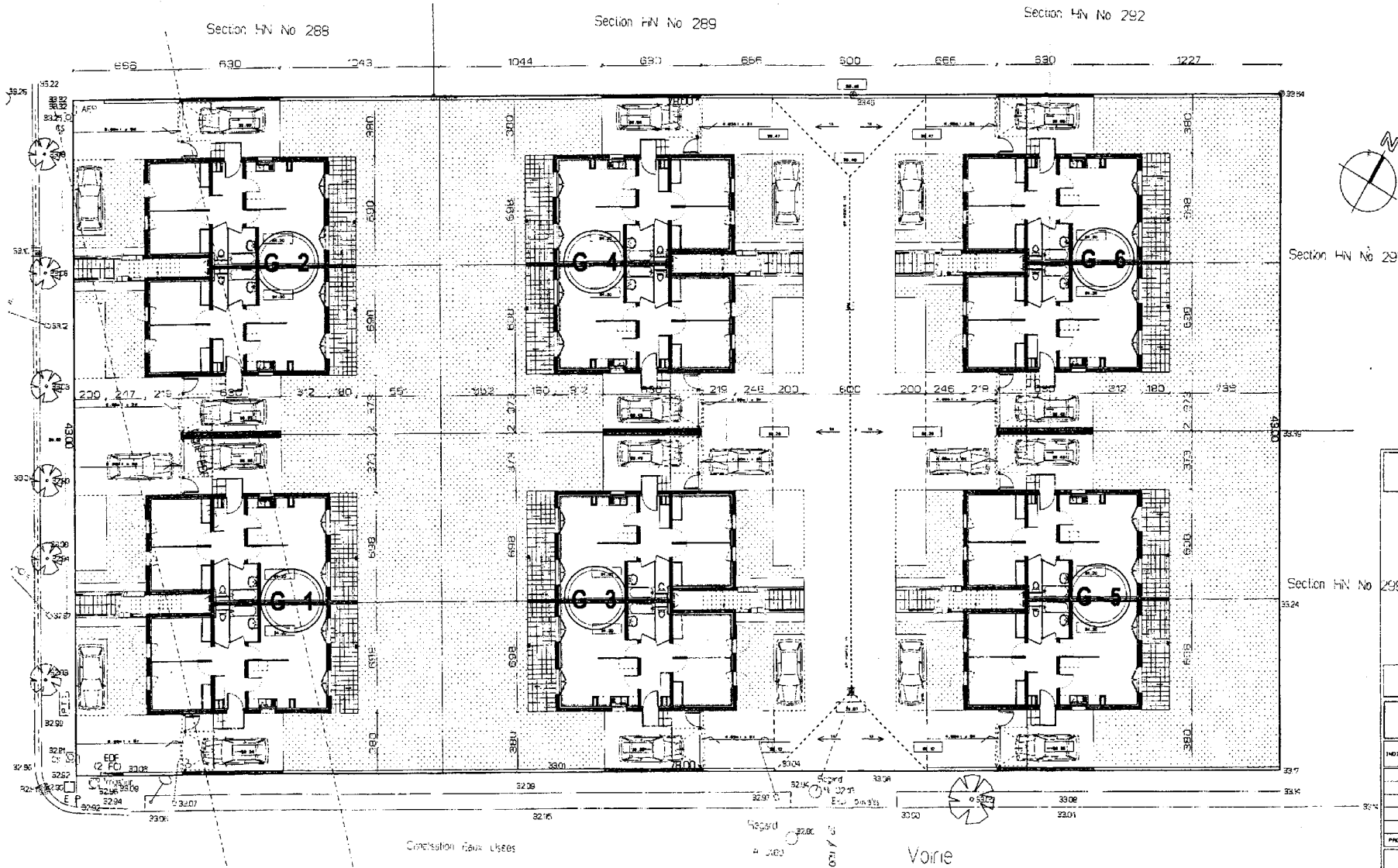

Commune de		PLAN	
S.C.I			
Construction de 6 maisons en individuel groupe			
CONSULTATION DES ENTREPRISES			
PLAN D'IMPLANTATION			
INDICE	DATE	MODIFICATION	ECHELLE :
			DATE :
			PHASE
			APS PC DCE DH
PROJETEUR	FIGURER		

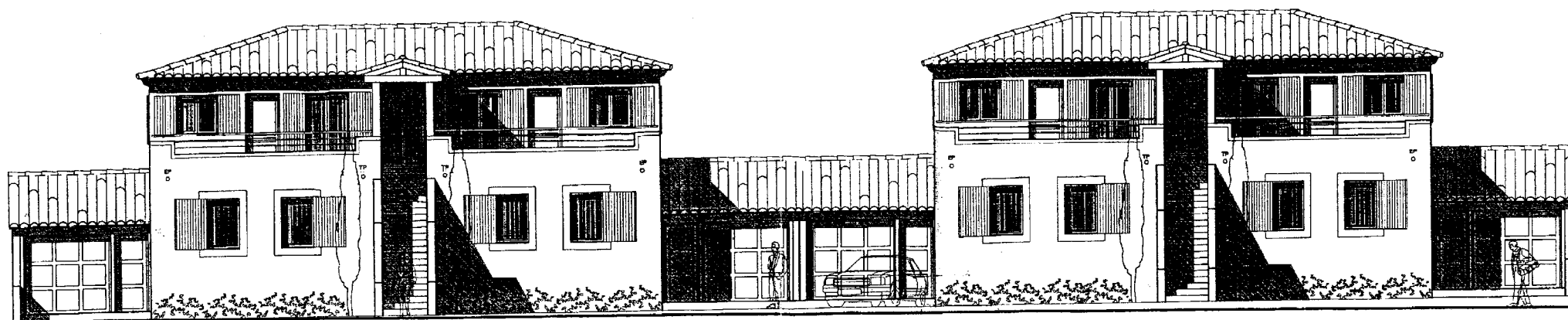

FACADE SUR ENTREES

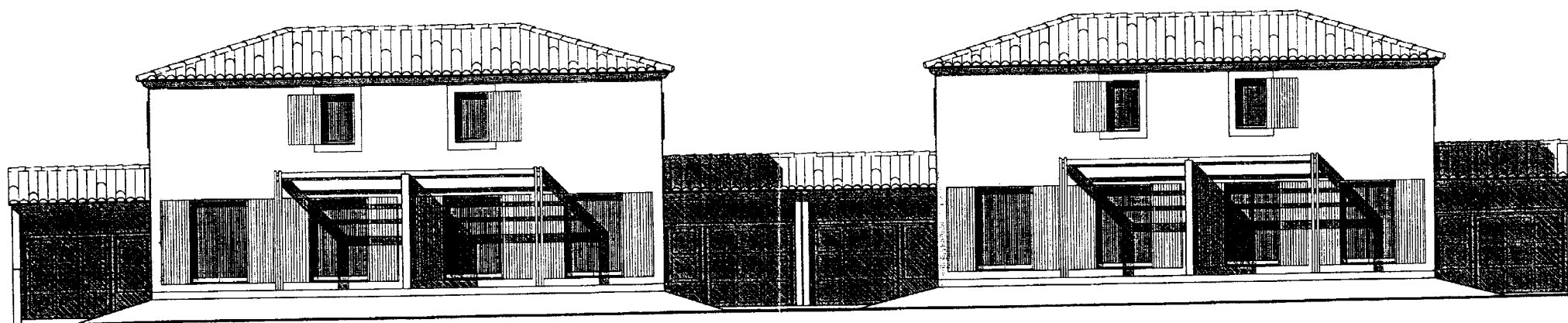

FACADE SUR JARDINS

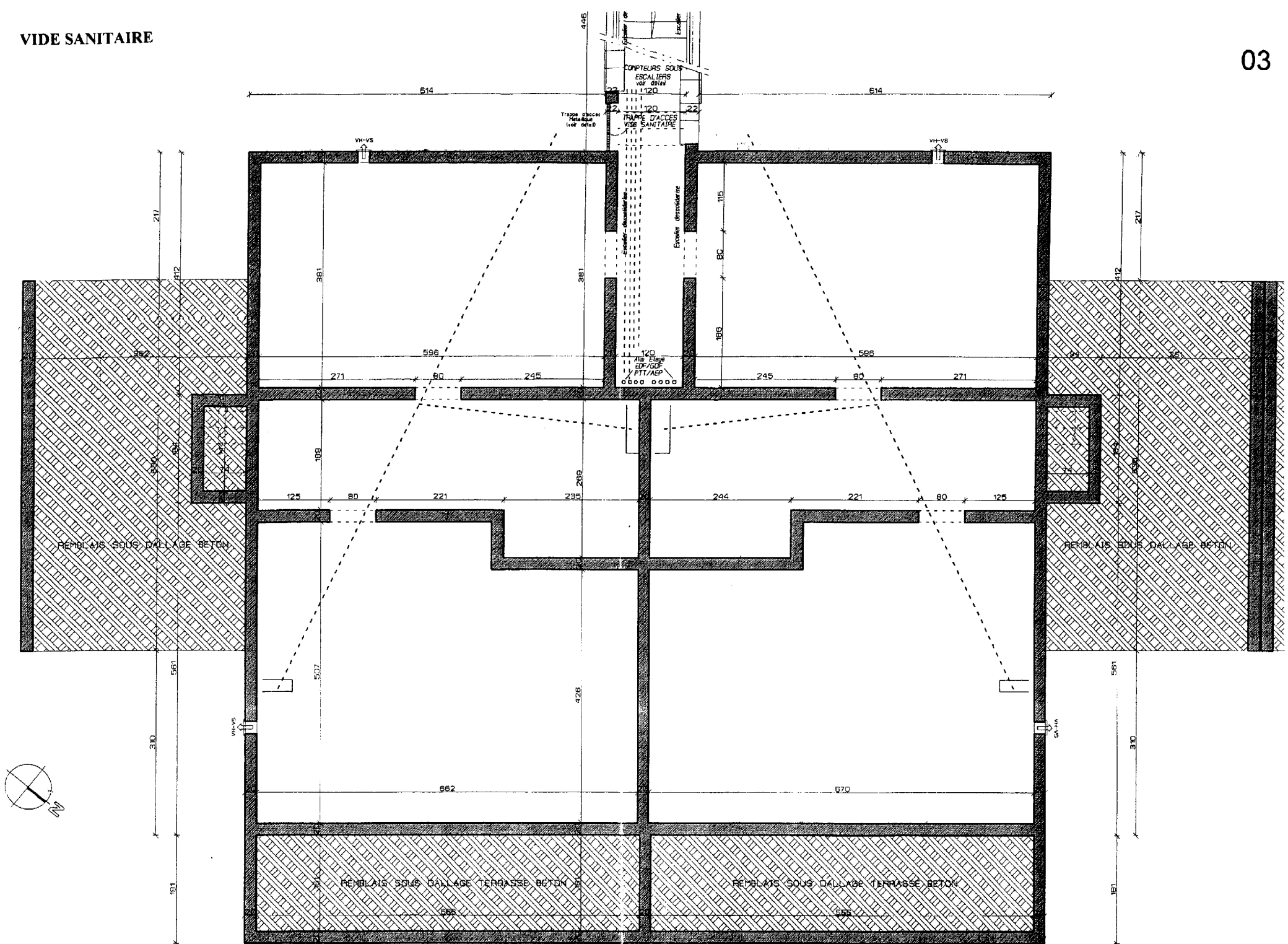

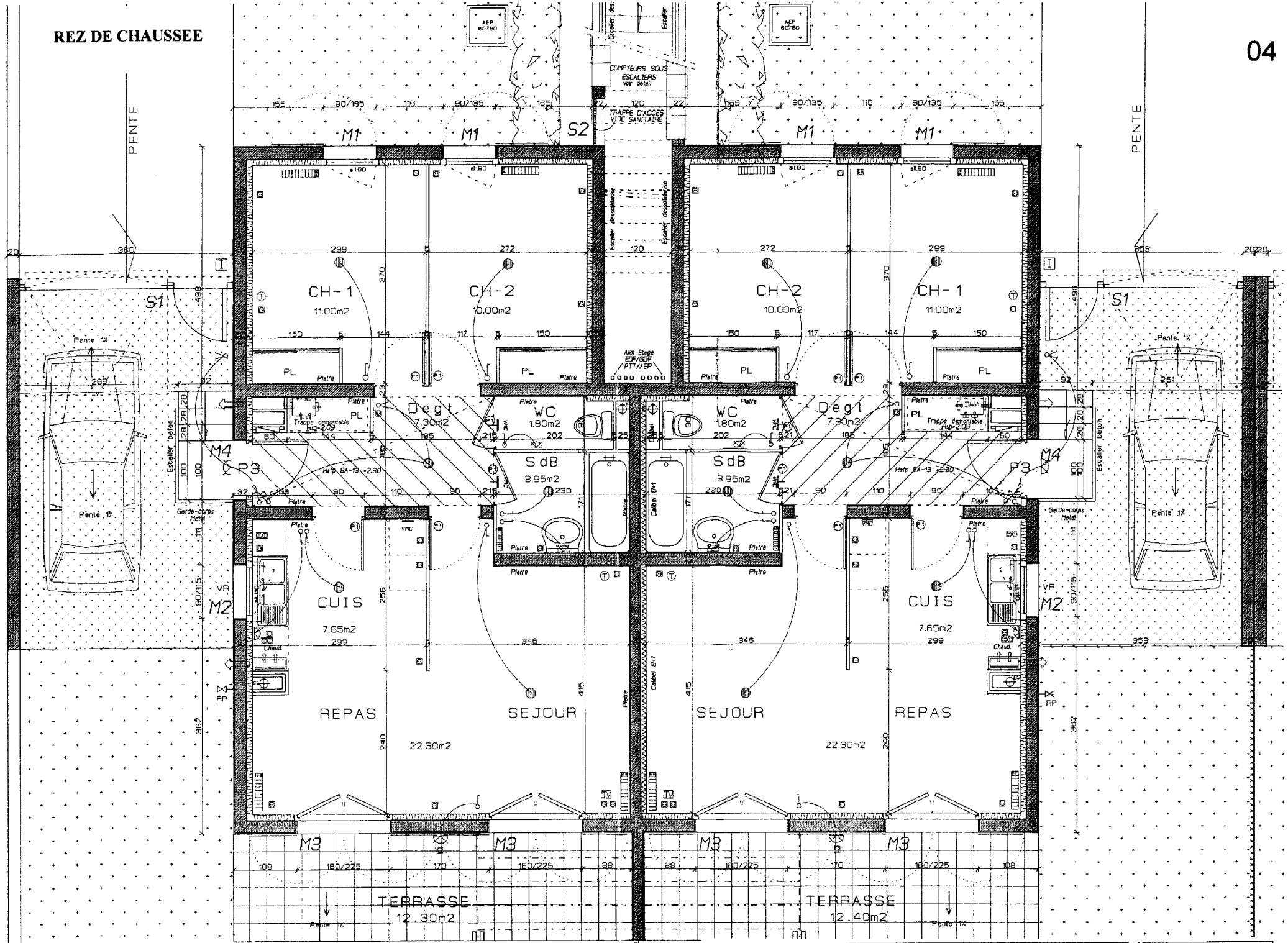

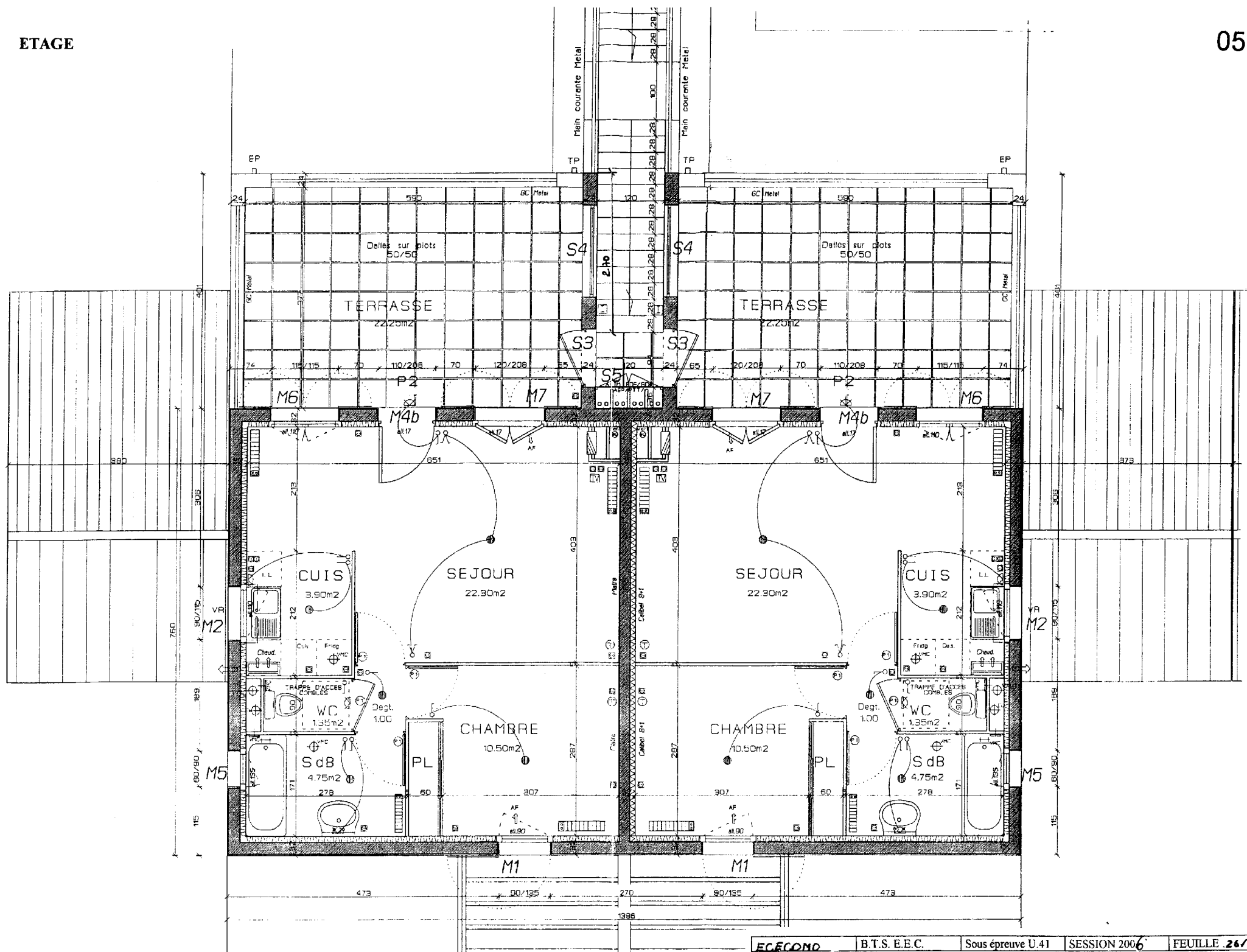

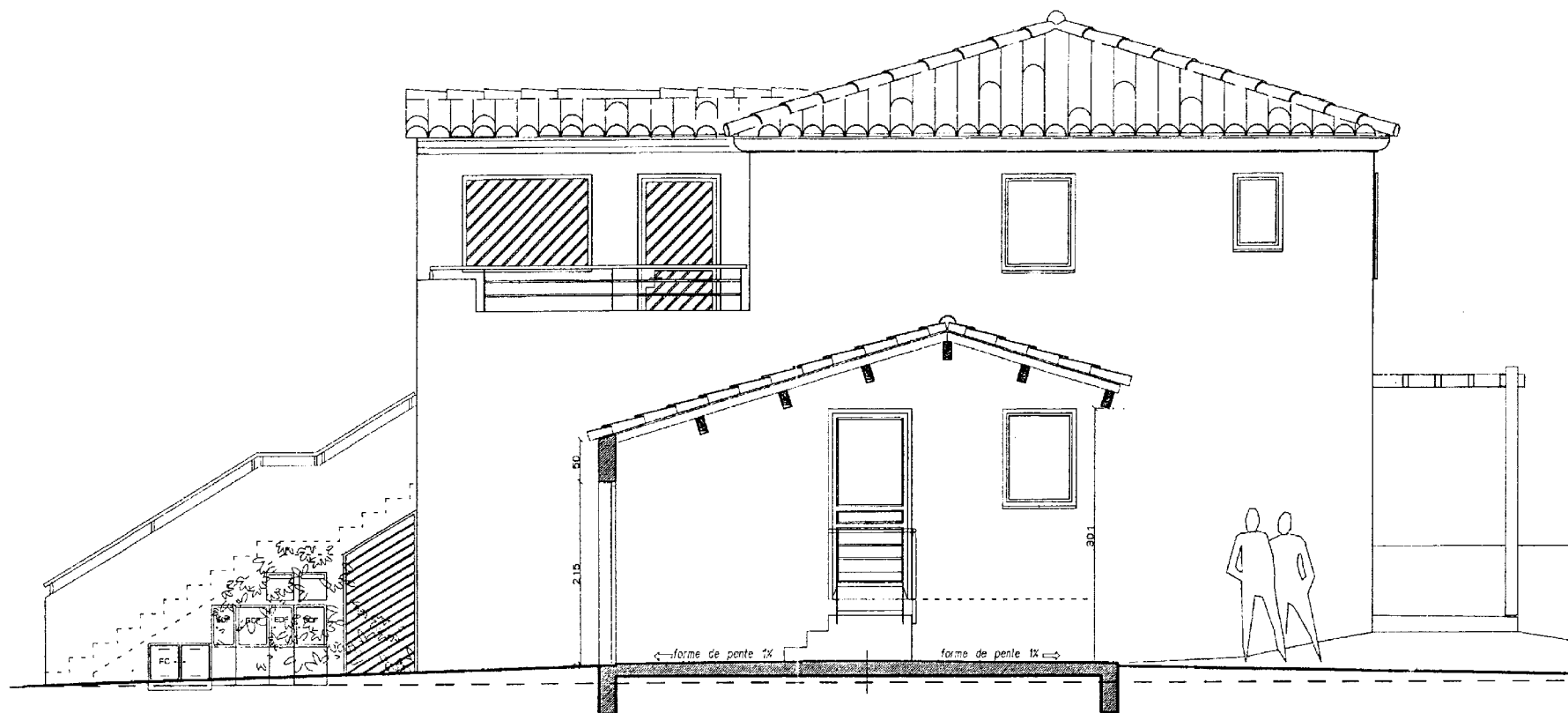

COUPE SUR GARAGE / FACADE LATERALE

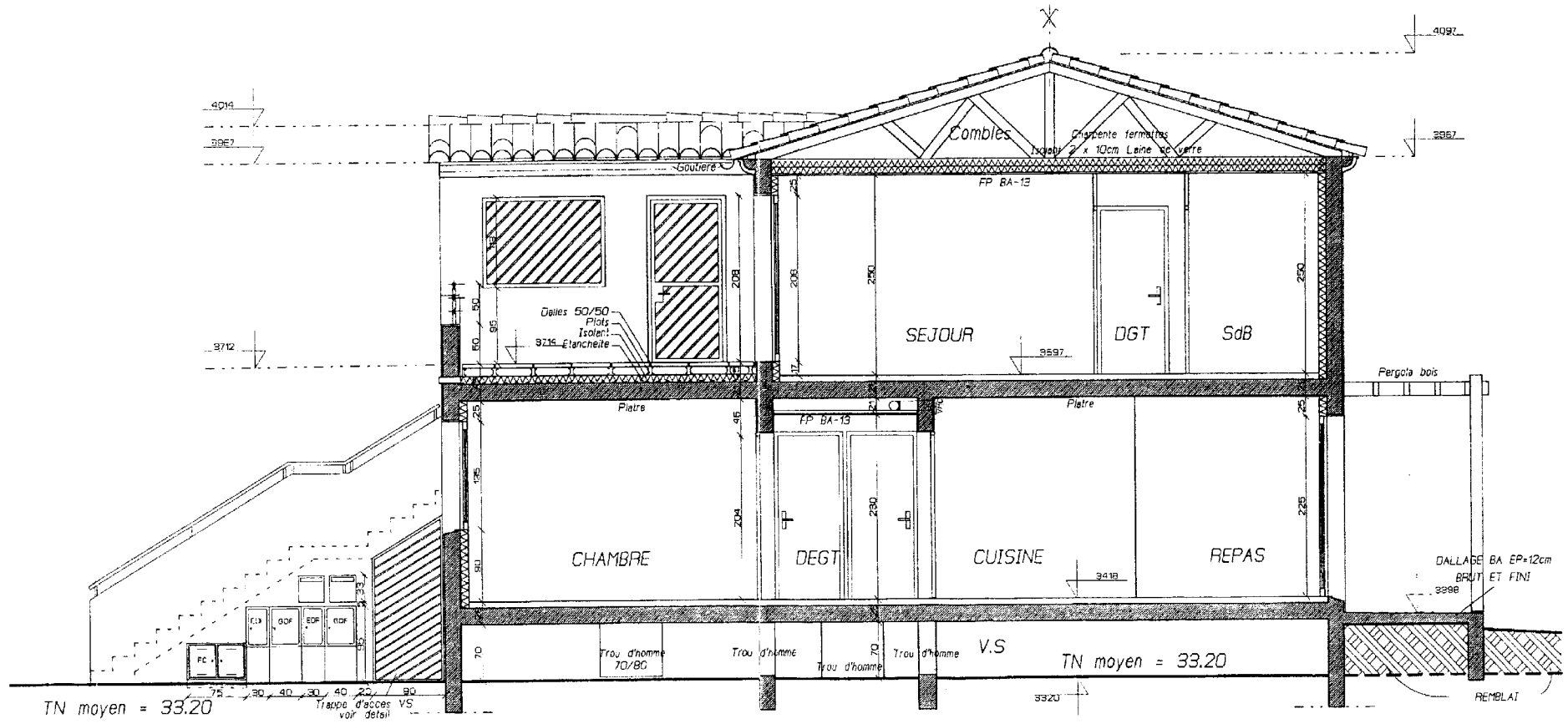

COUPE SUR LOGEMENT

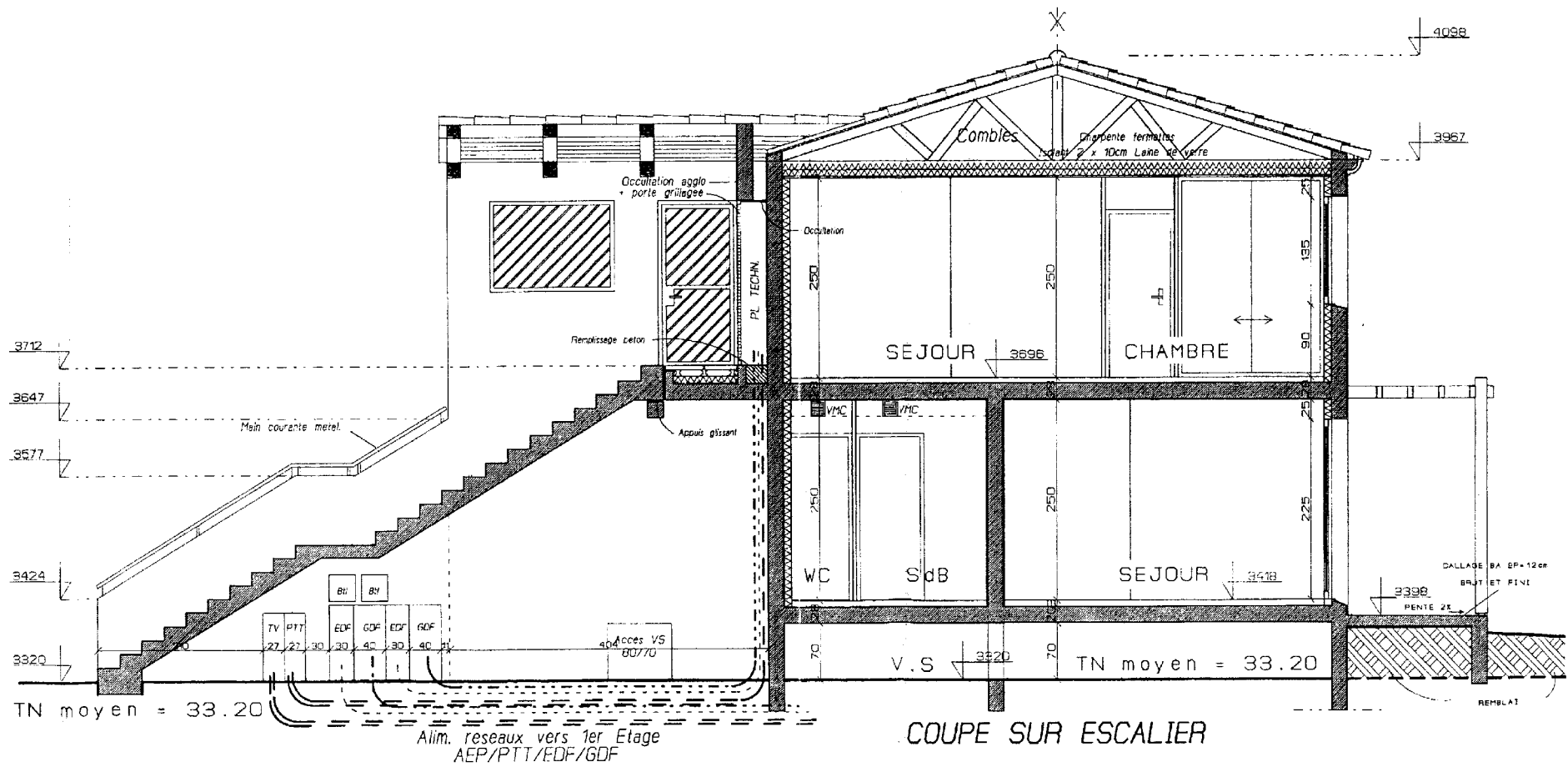

COUPE SUR ESCALIER



Légende

- Poteaux Béton
- ▨ Raidisseurs

FONDACTIONS VUE EN PLAN DE COFFRAGE

01a

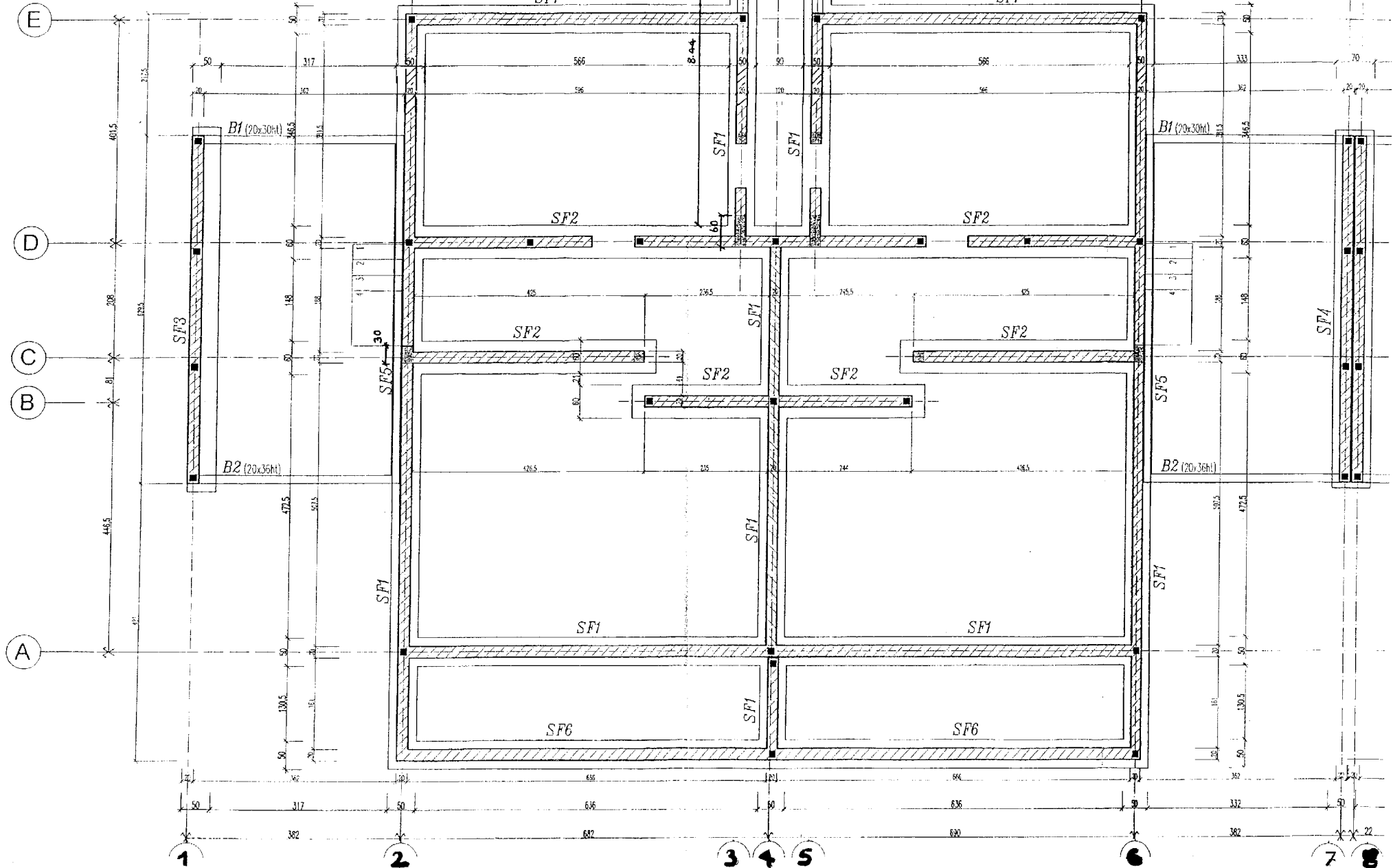

03c

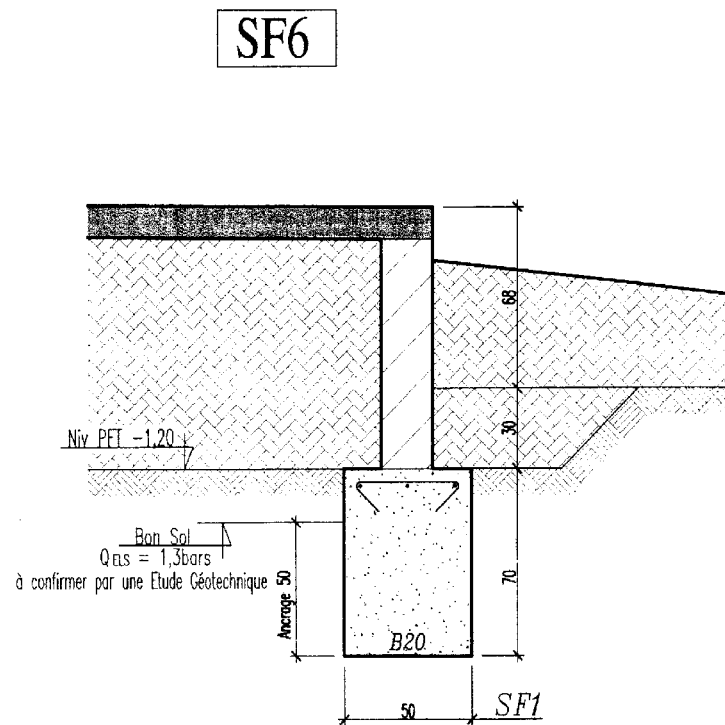
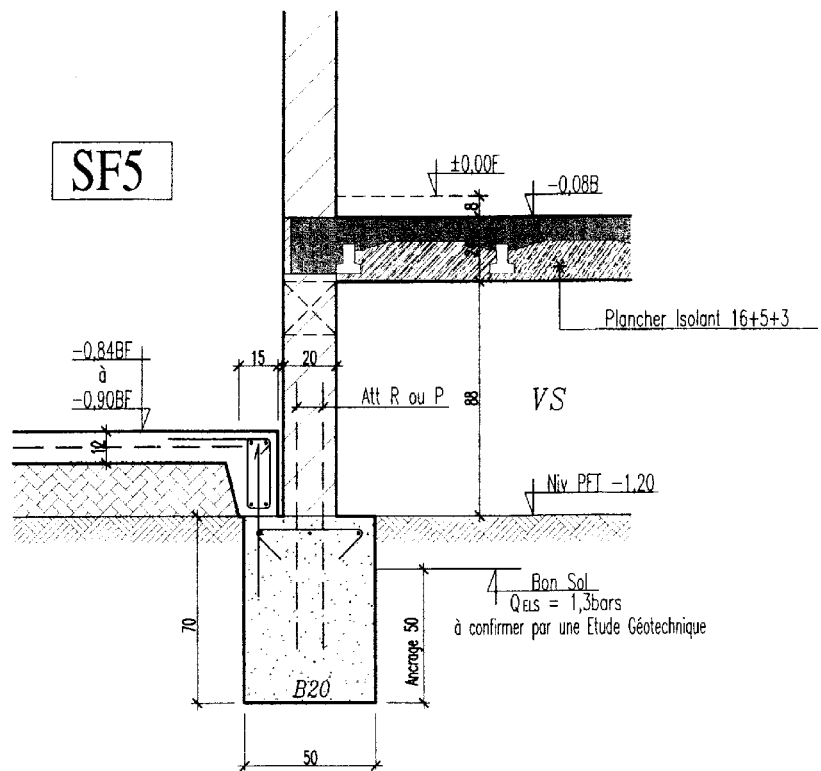

	Projet :	titre :	Foundations	Dossier N°	Ech :	Plan N°	PAGE : 03
			Plancher Haut du VS				
			Détails Coupes		1/20°	03	

03b

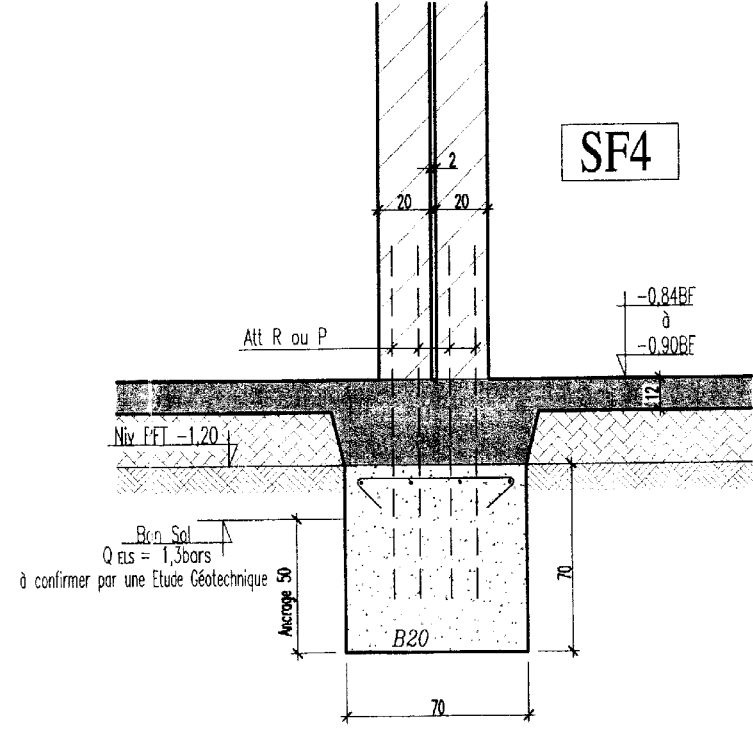
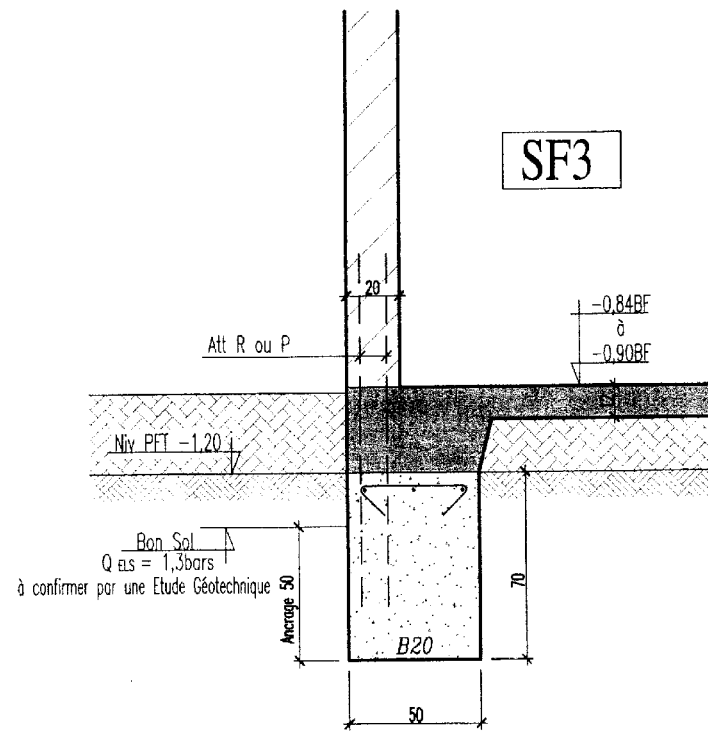

Projet :	titre :	Fondations Plancher Haut du VS Détails Coupes	Dossier N°	Ech :	Plan N°	PAGE : 02
				1/20°	03	

SF1 - SF2

