

BREVET PROFESSIONNEL

CHARPENTE BOIS **SESSION 2007**

SUJET NATIONAL

REALISATION D'UN OUVRAGE COMPLEXE EPREUVE E3

Coefficient 7

BREVET PROFESSIONNEL CHARPENTIER			
CORRIGÉ	Session 2007	Durée : 24h00	Coef : 7
Epreuve E3 : Réalisation d'un ouvrage complexe			Page 1/4

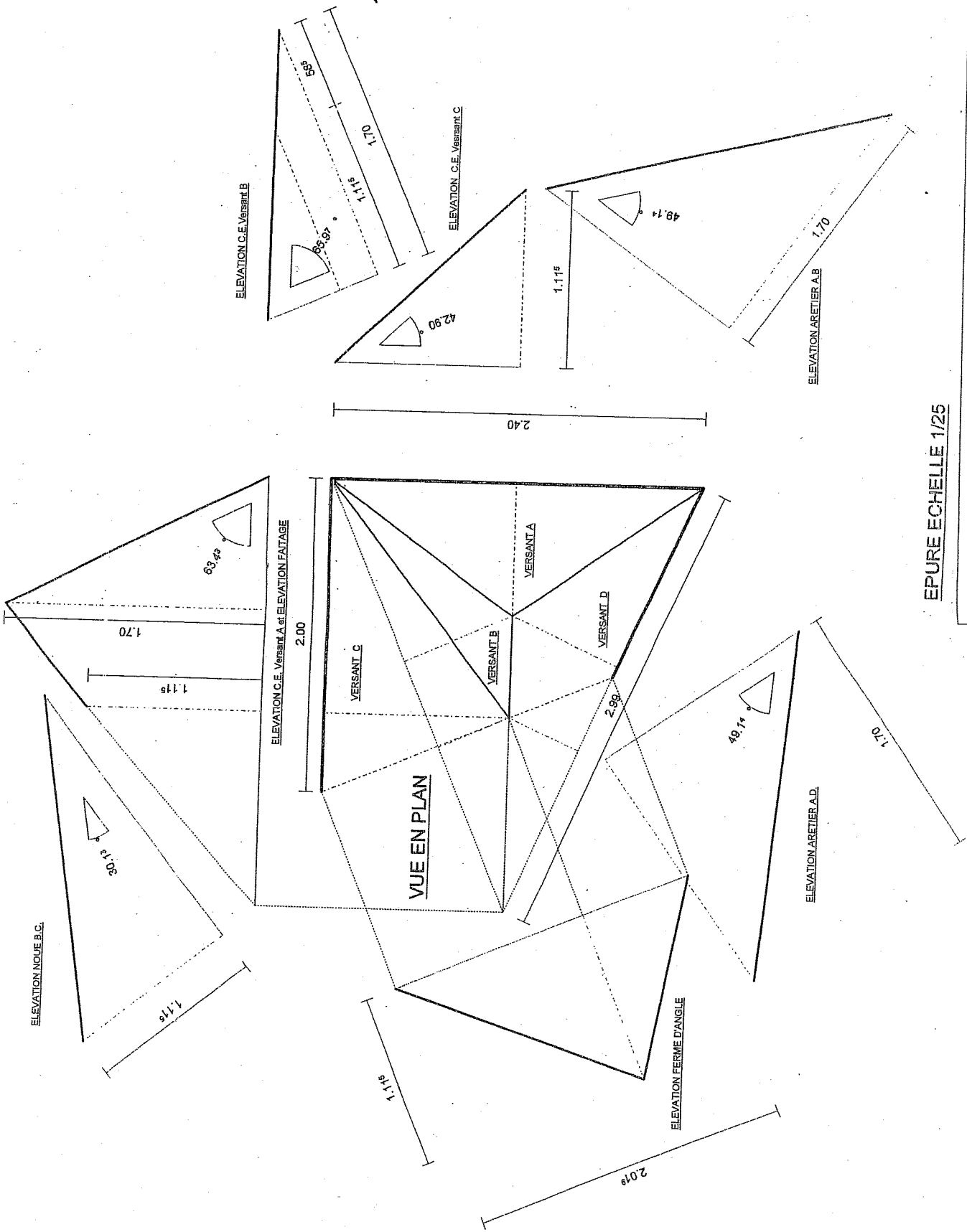

EPURE ECHELLE 1/25

BREVET PROFESSIONNEL CHARPENTIER			
CORRIGÉ	Session 2007	Durée : 24h00	Coef : 7
Epreuve E3 : Réalisation d'un ouvrage complexe		Page 2/4	

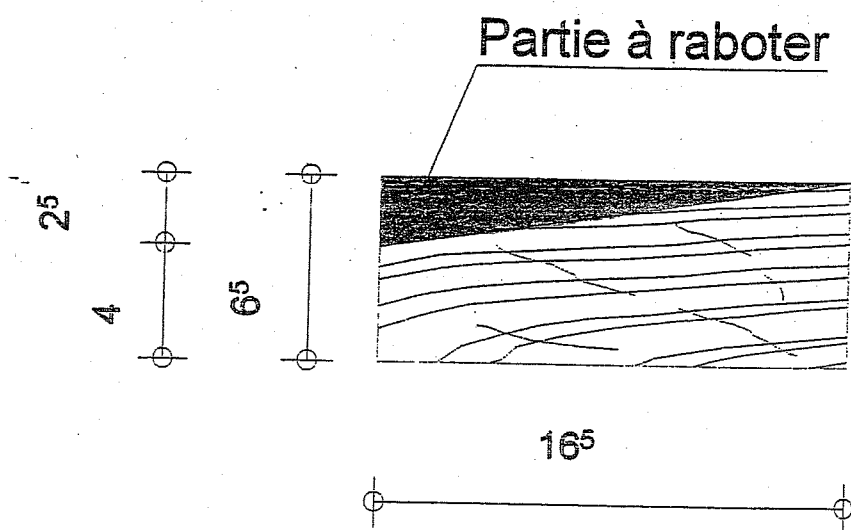

DELARDEMENT DE L'ARETIER B. C.

BREVET PROFESSIONNEL CHARPENTIER

CORRIGÉ

Session 2007

Durée : 24h00

Coef : 7

Epreuve E3 : Réalisation d'un ouvrage complexe

Page 3/4

52

28

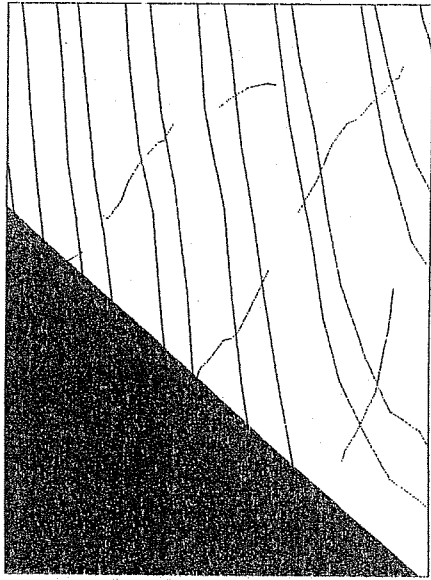
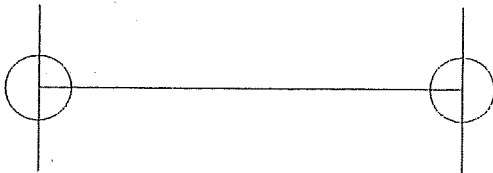
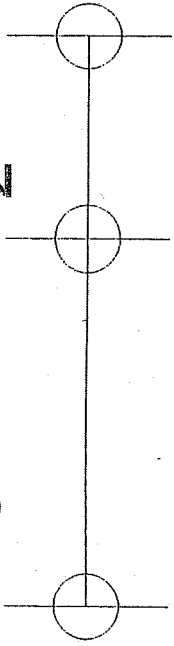

8

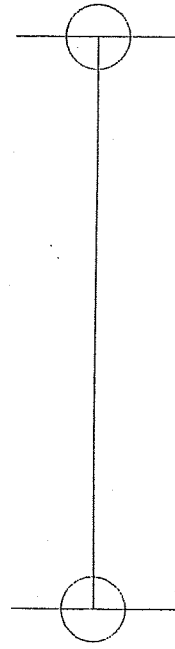

VUE PAR BOUT
DU CHEVRON
DE RIVE D

44

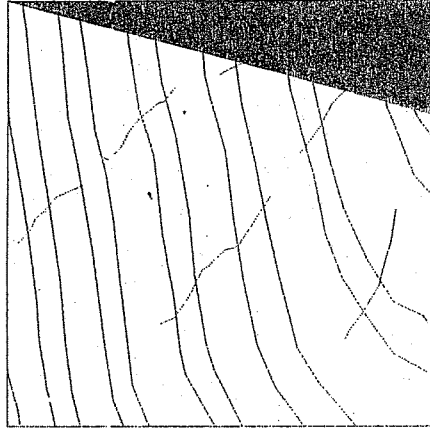
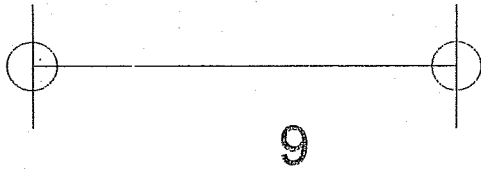
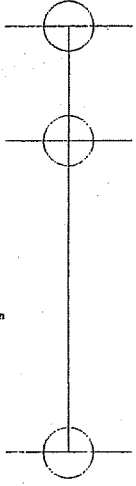

6

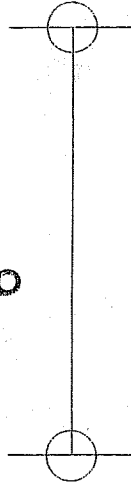

VUE PAR BOUT
DU CHEVRON
DE RIVE C