

Annexe 1b

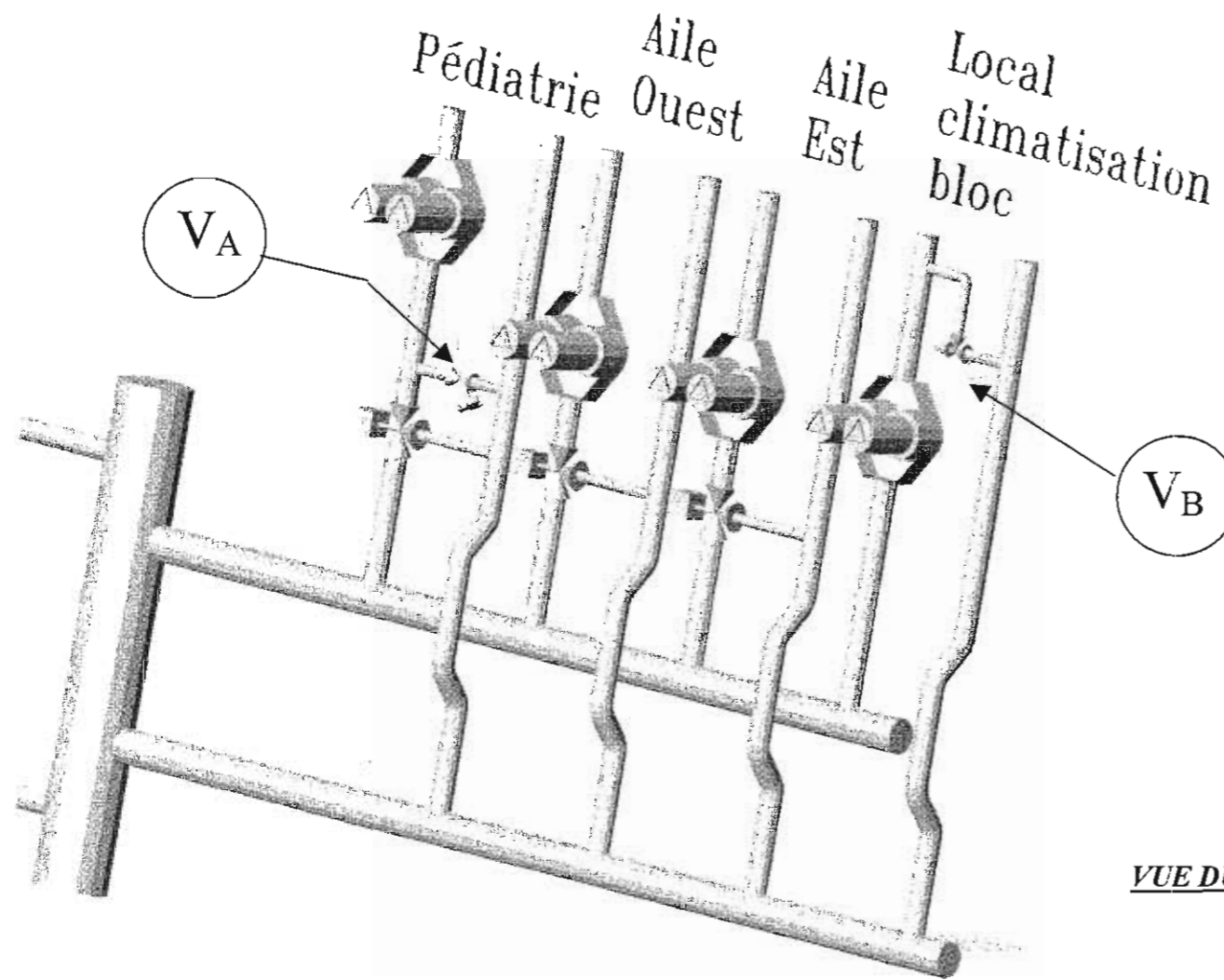

VUE DU LOCAL CHAUFFERIE
Bâtiment actuel

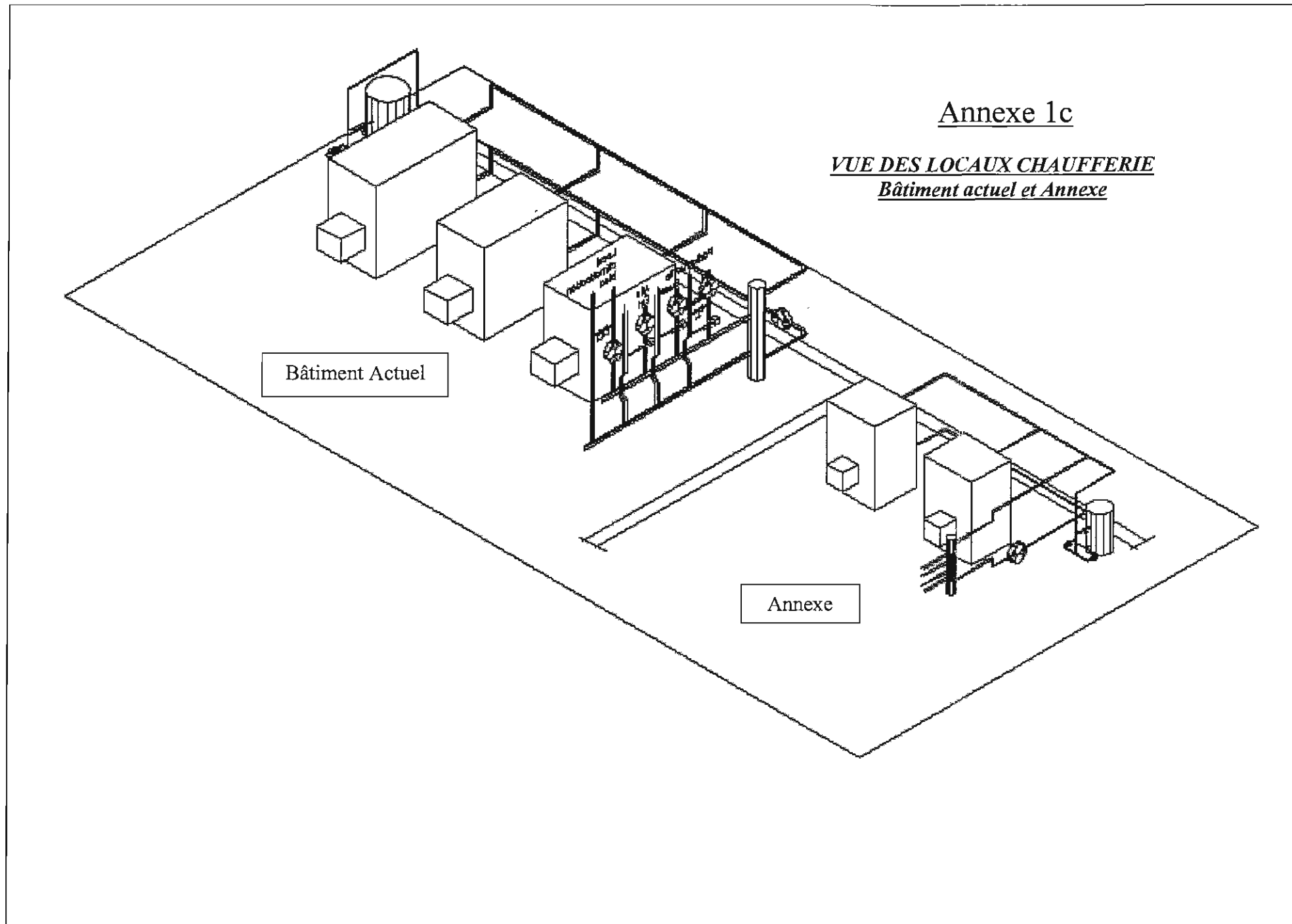

Annexe 1c

VUE DES LOCAUX CHAUFFERIE
Bâtiment actuel et Annexe

Bâtiment Actuel

Annexe

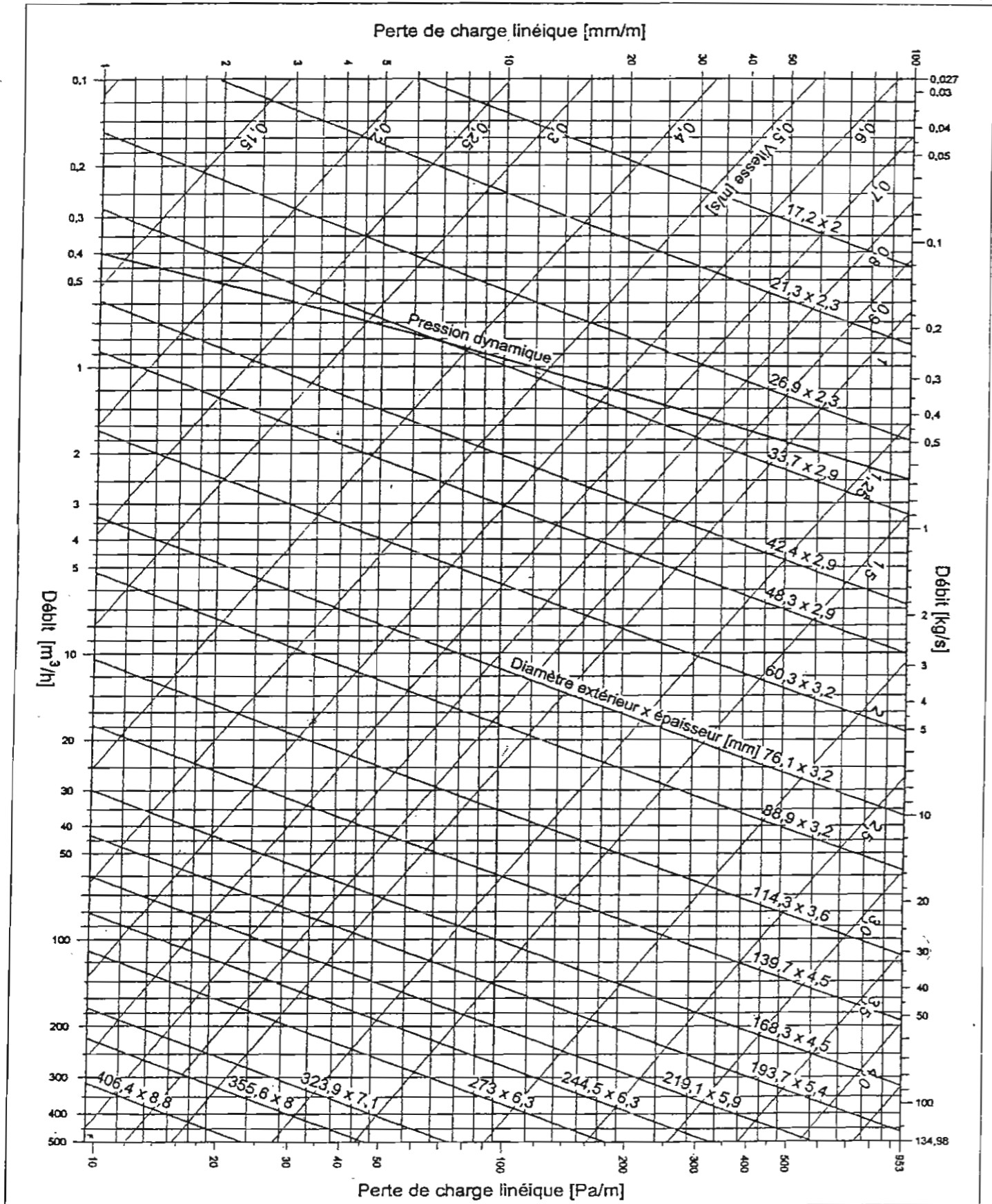

UPS 40-60/2 F, UPSD 40-60 F

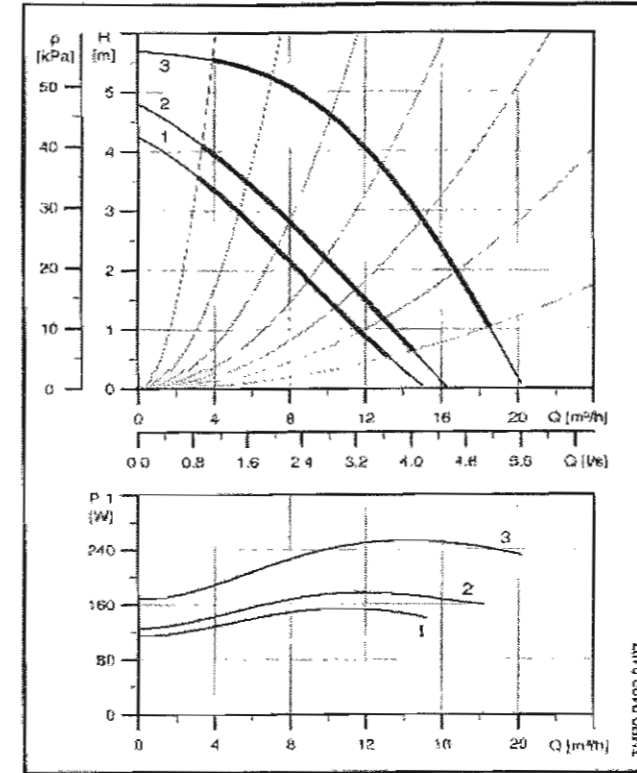

UPS 50-60/4 F, UPSD 50-60/4 F

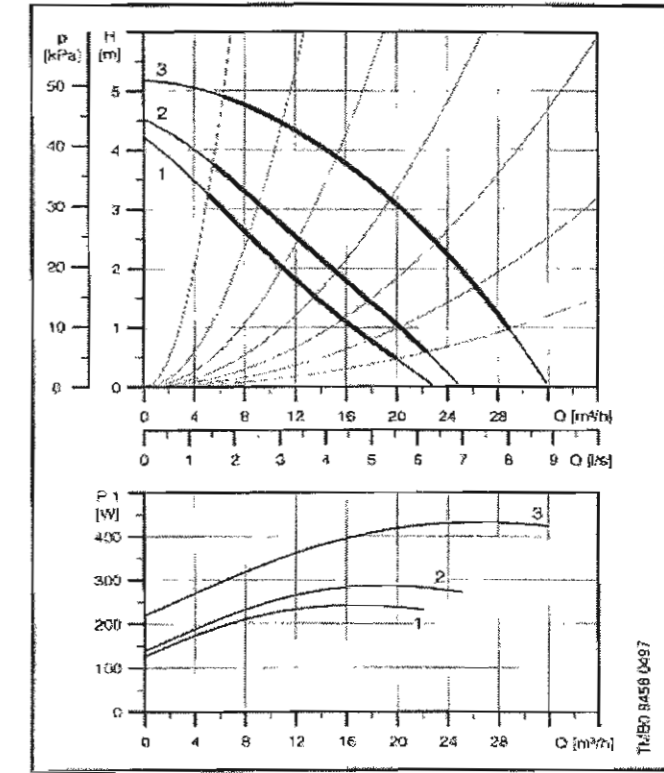

UPS 40-30 F, UPSD 40-30 F

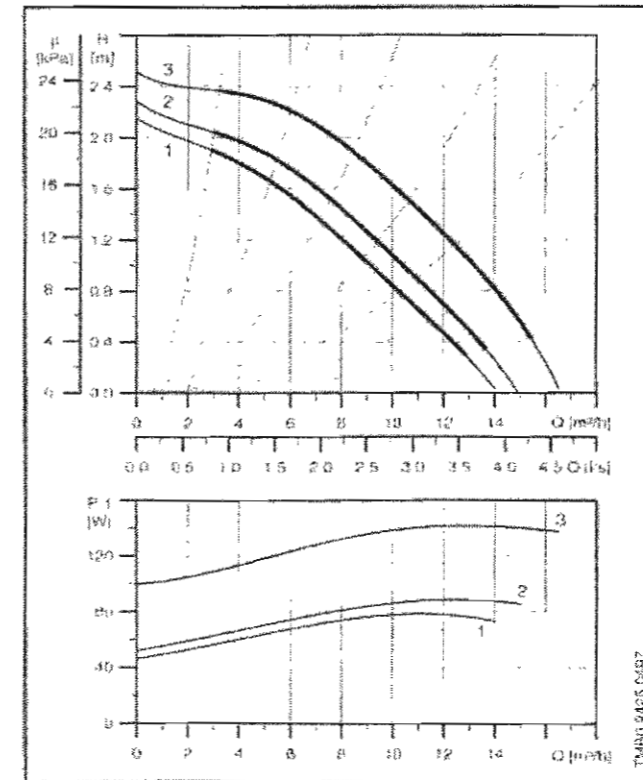

UPS 40-180 F

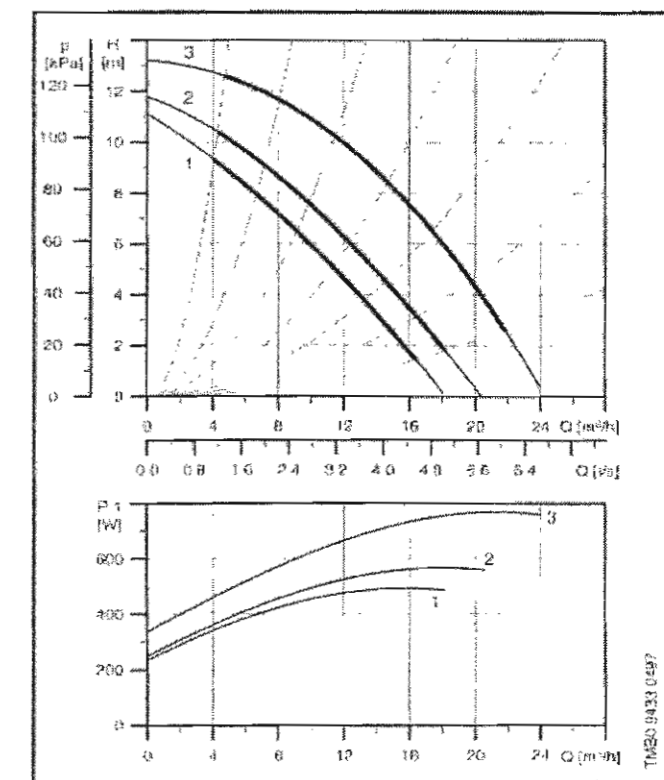

Annexe 2 : Schéma relevé par les techniciens

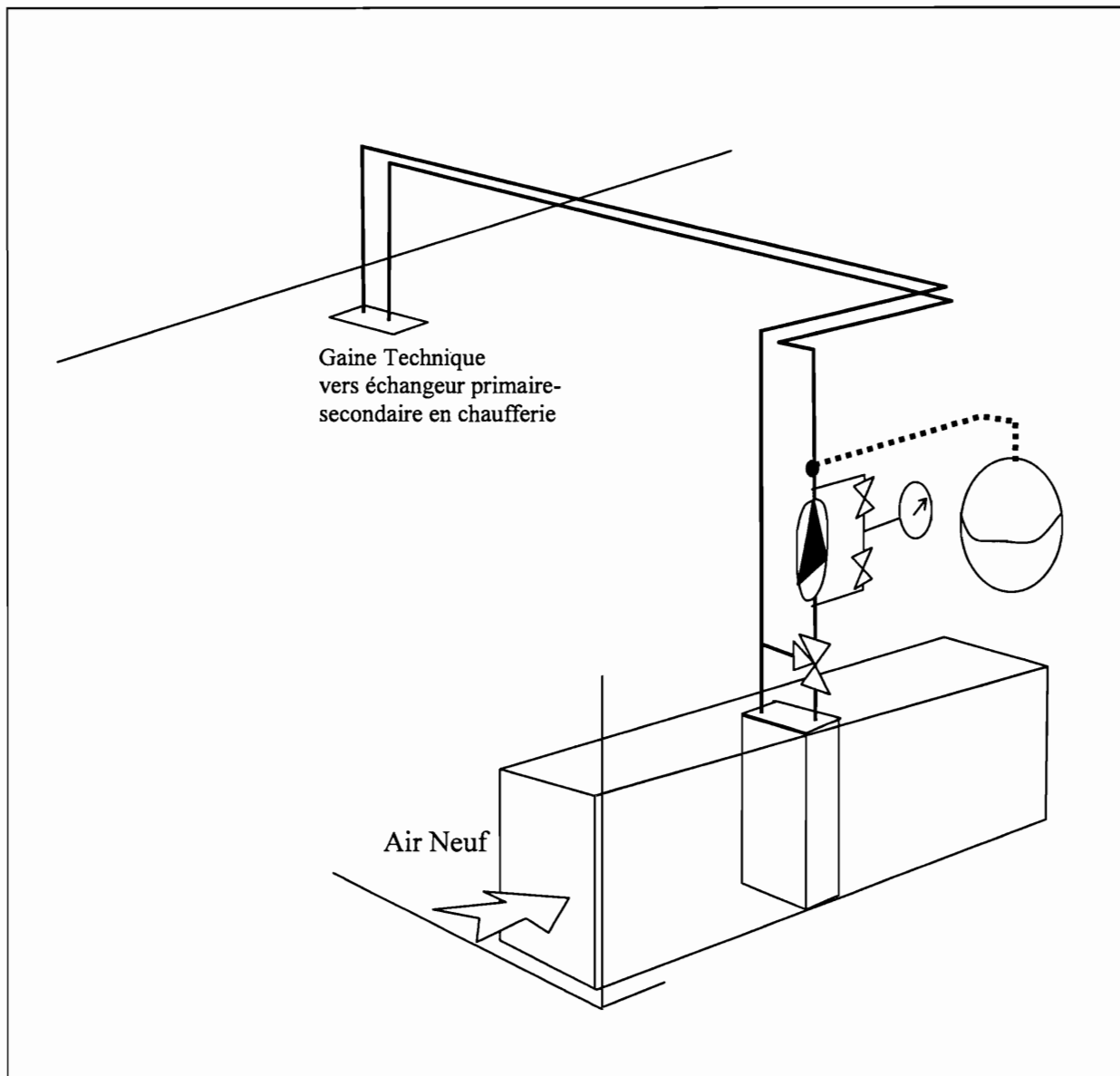

- Tableau des Pvs (pression absolue de vaporisation de l'eau)

T (°C)	10	20	30	40	50	60	70	80
Pvs (bar)	0,012	0,023	0,042	0,073	0,157	0,199	0,311	0,473