

CAP DE MENUISIER EN SIÈGES	
ÉPREUVE : PRATIQUE D'ATELIER	DURÉE 24 H (TENONS) 20 H (TOURILLONS)
SESSION 2009	REPÈRE : 50234/II PAGE 2/3

CE PLAN EST EN 2 PARTIES 2/3 ET 3/3

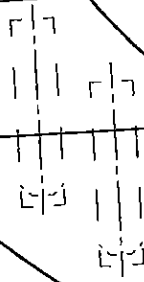

CRDP LORRAINE

CRDP LORRAINE

0'

1'

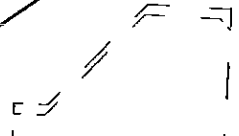

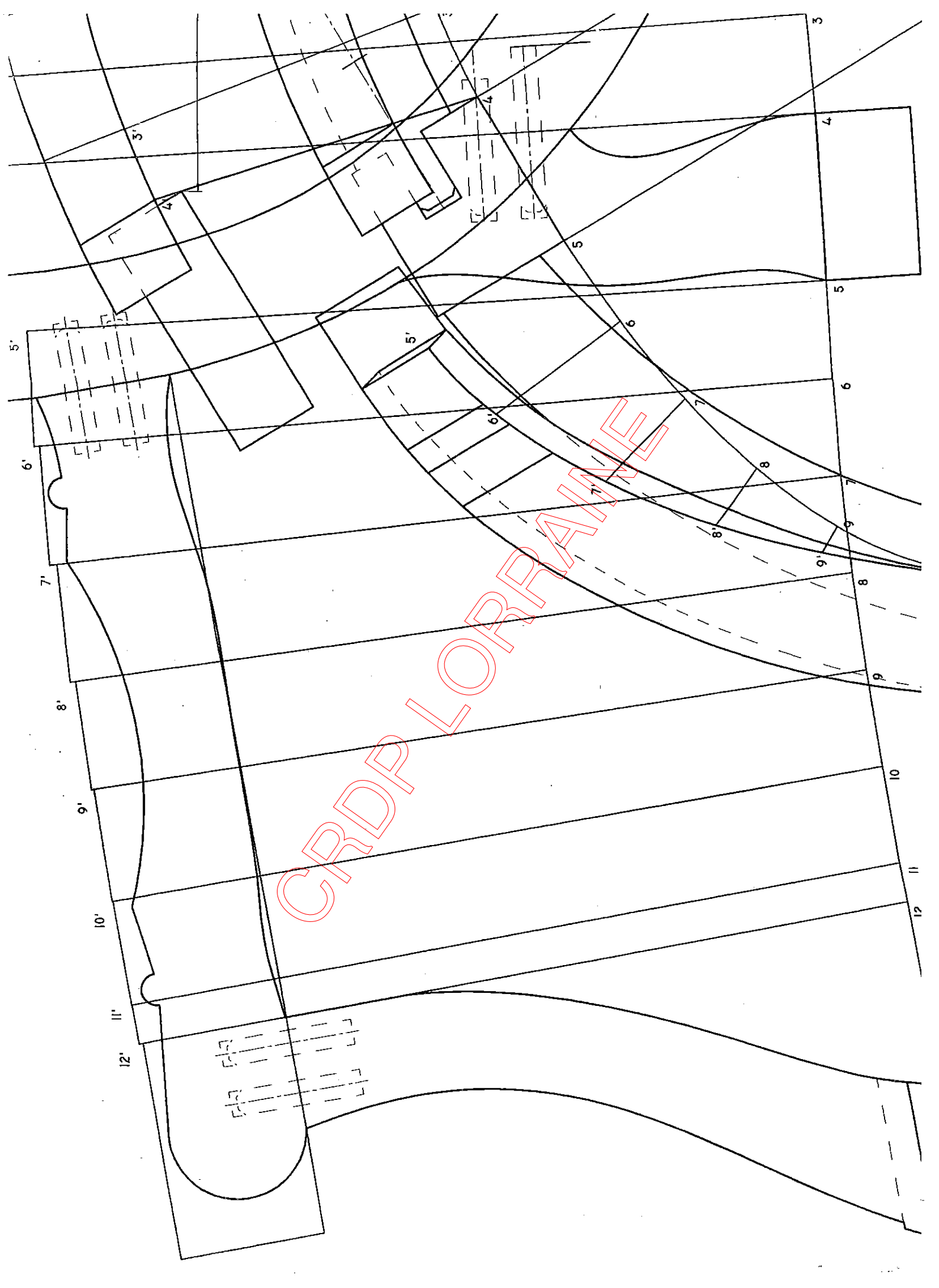

DISTANCE ENTRE TÊTES DE PIEDS 300 MM

CRDP LORRAINE

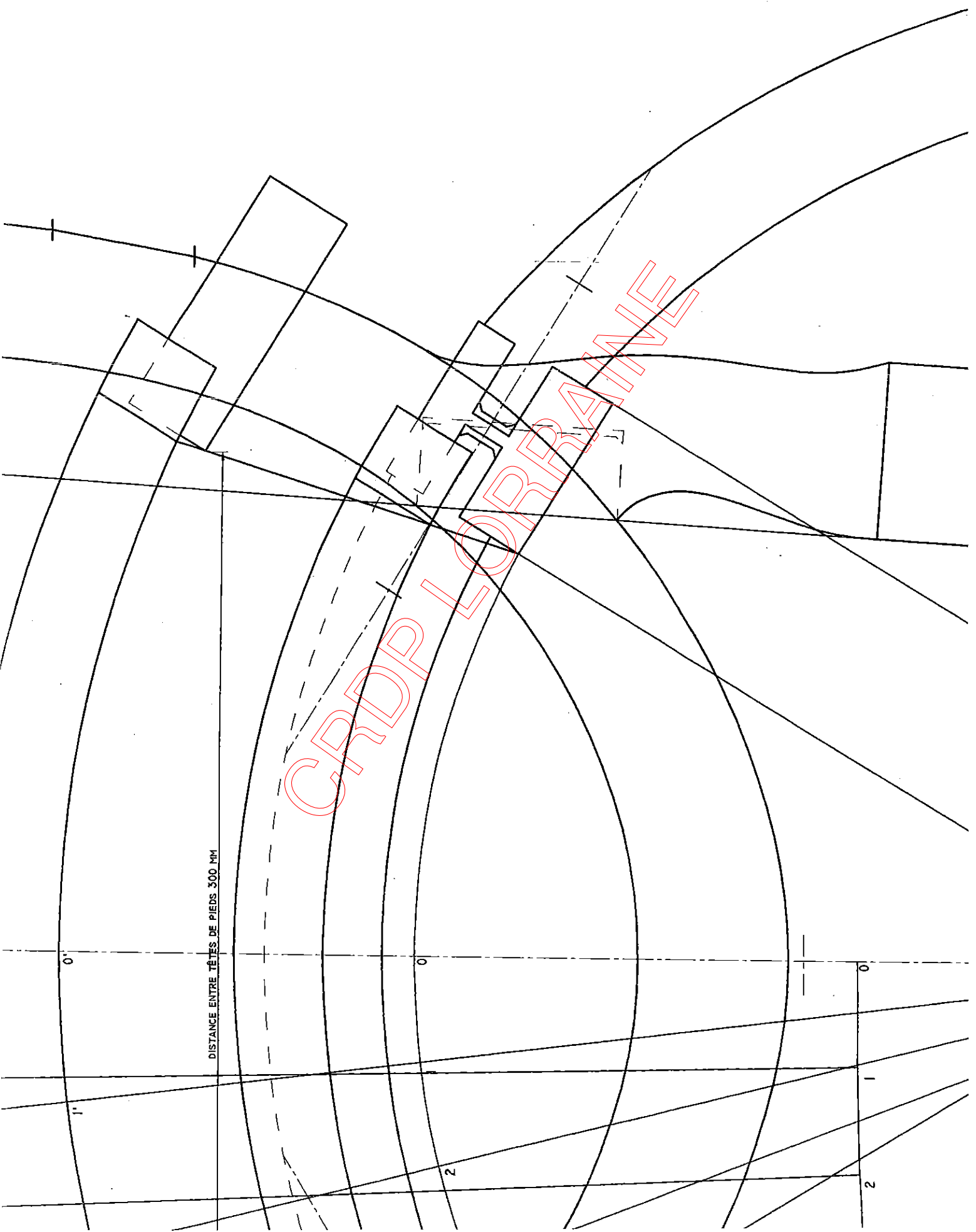

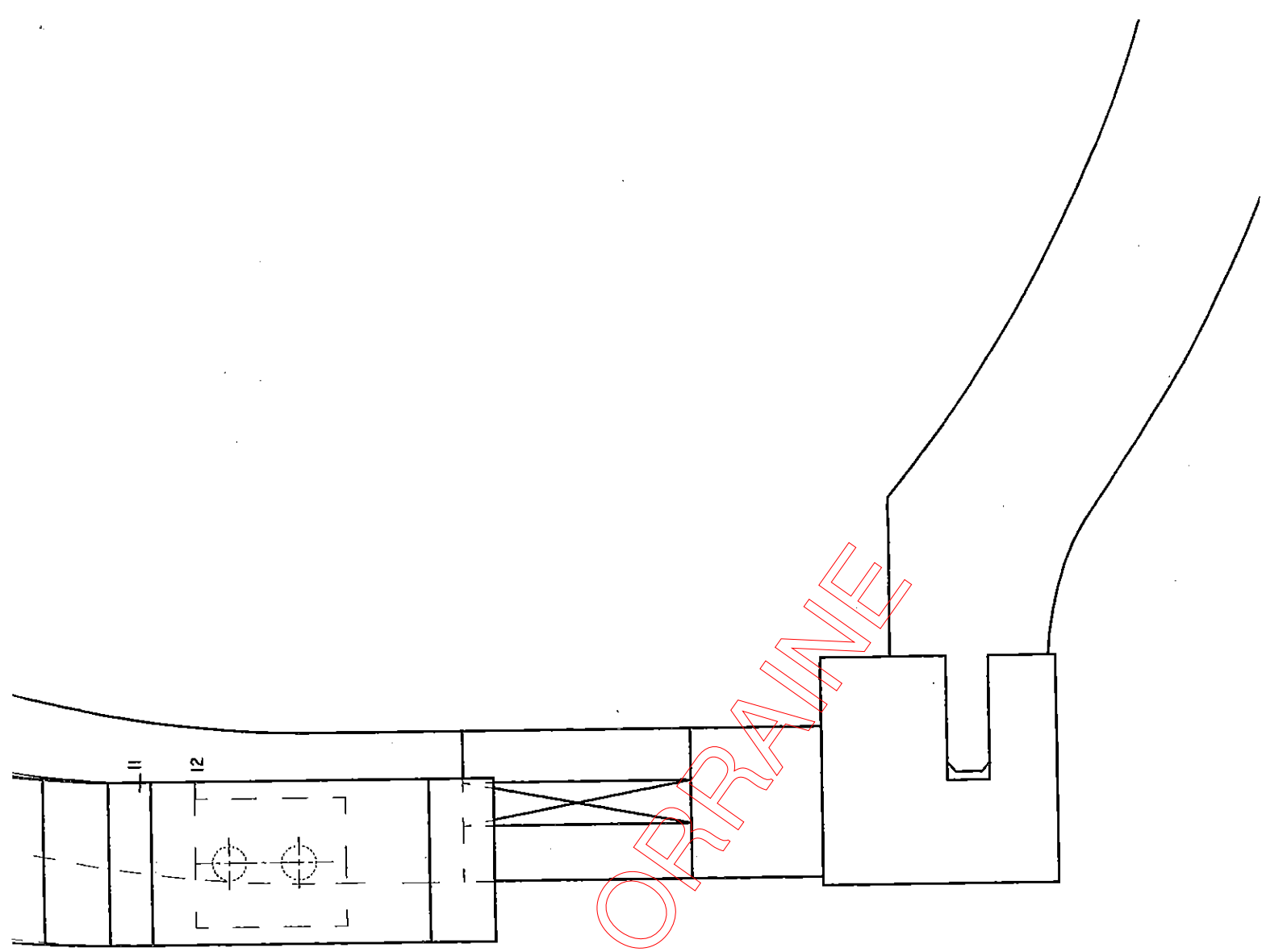

CRDP LORRAINE

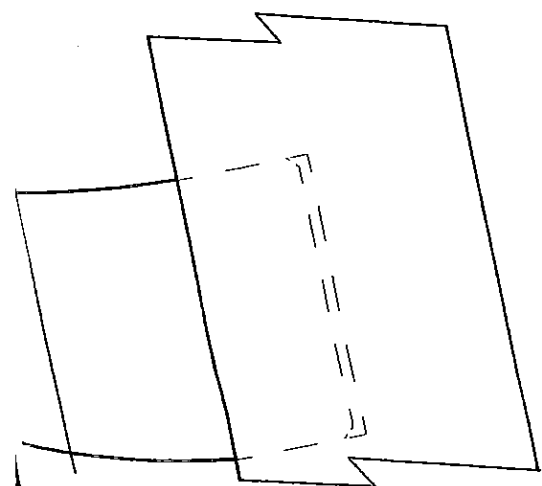

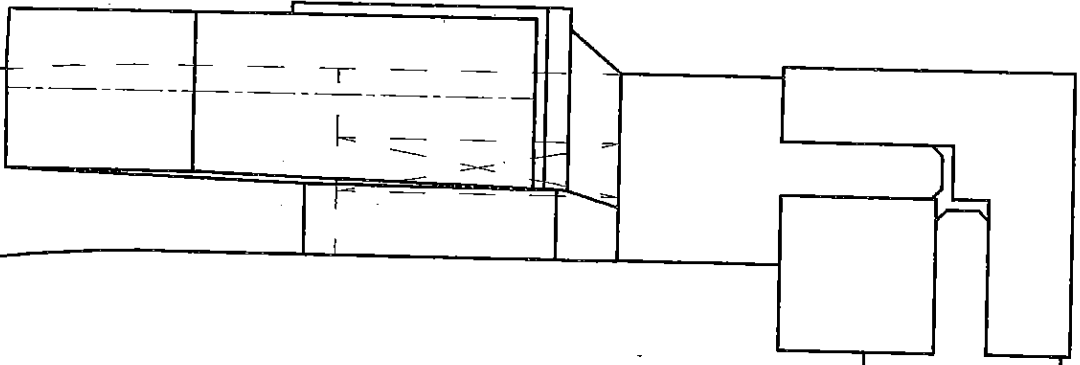

CRDP LORRAINE

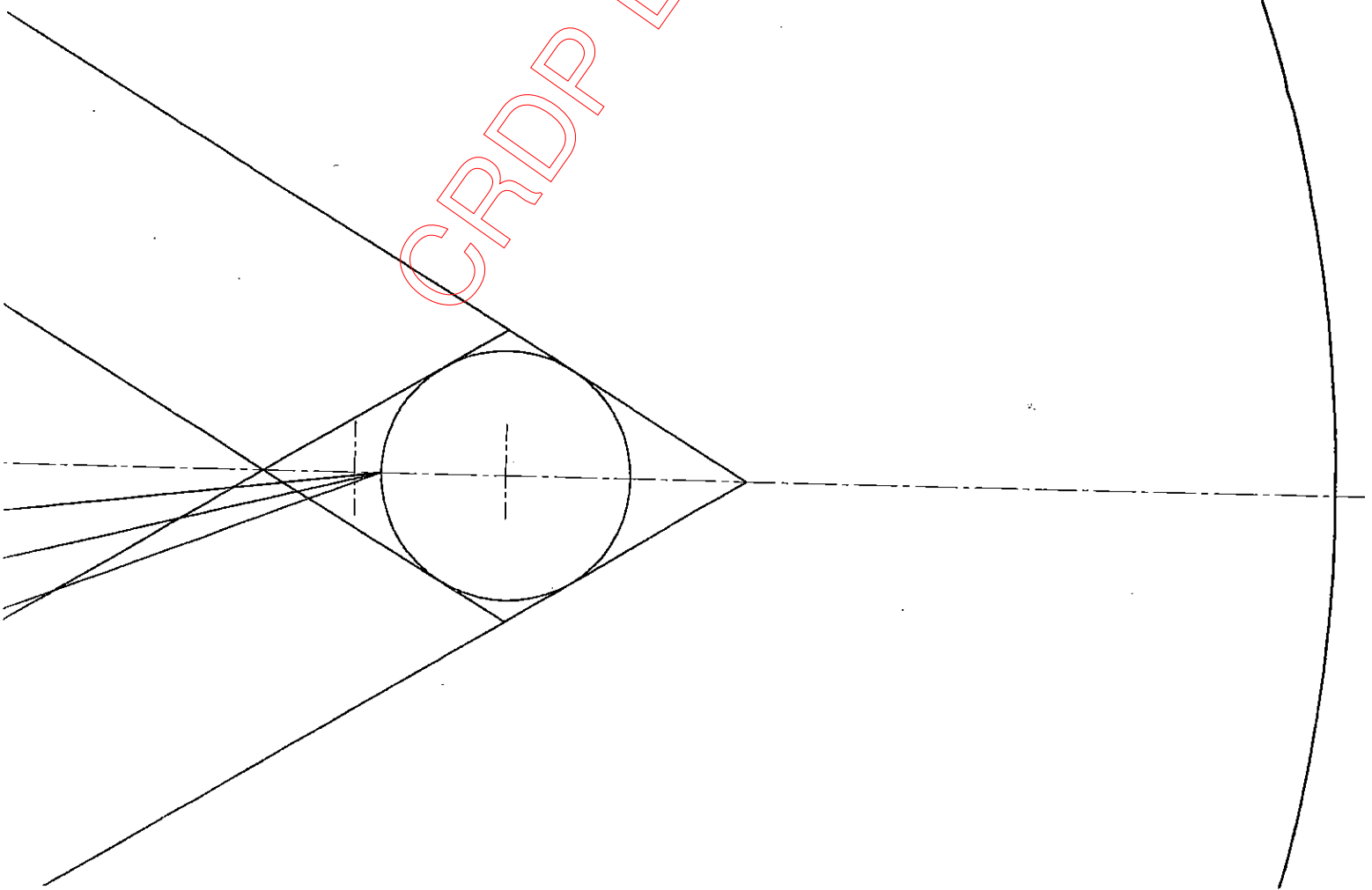

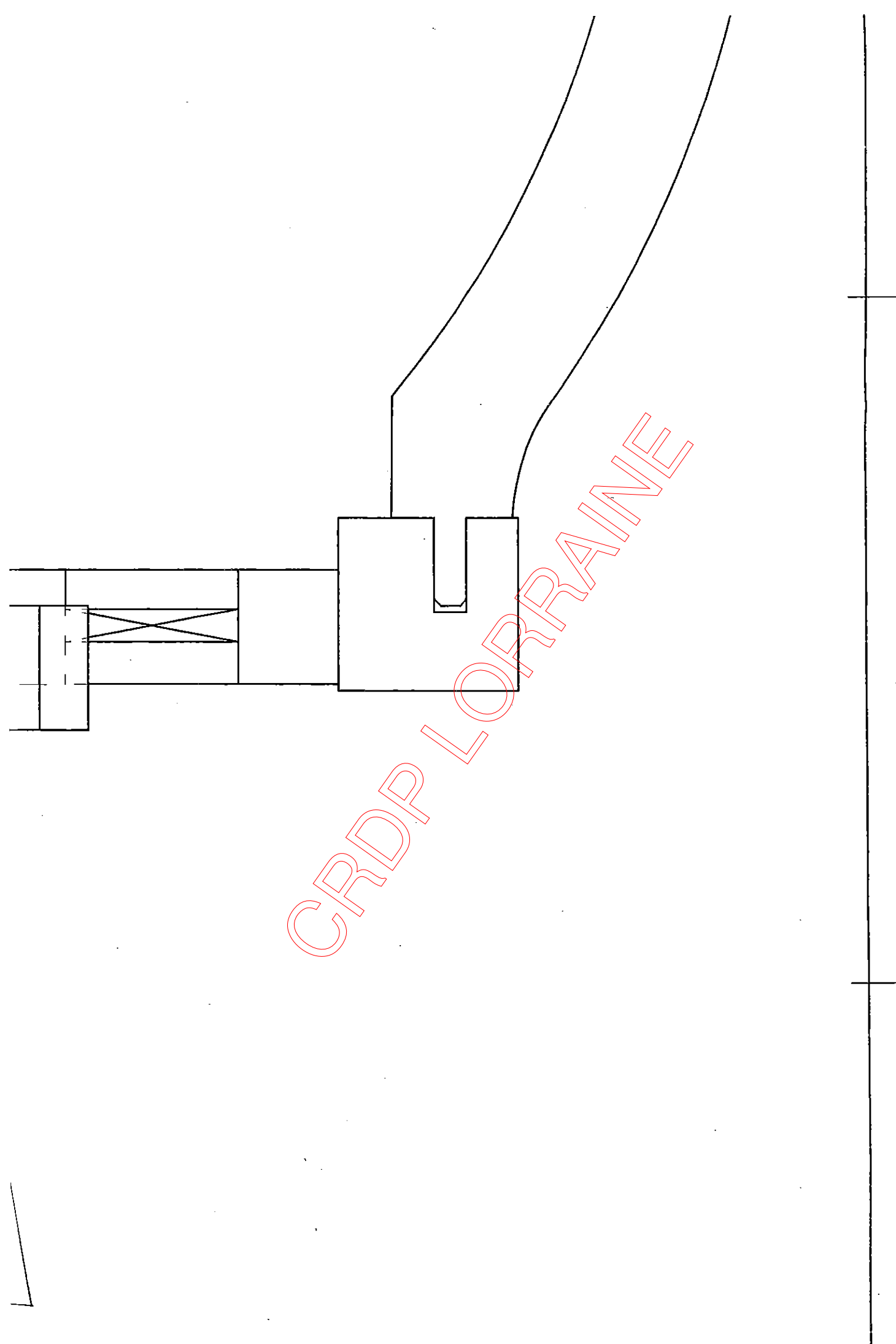

CRDP LORRAINE

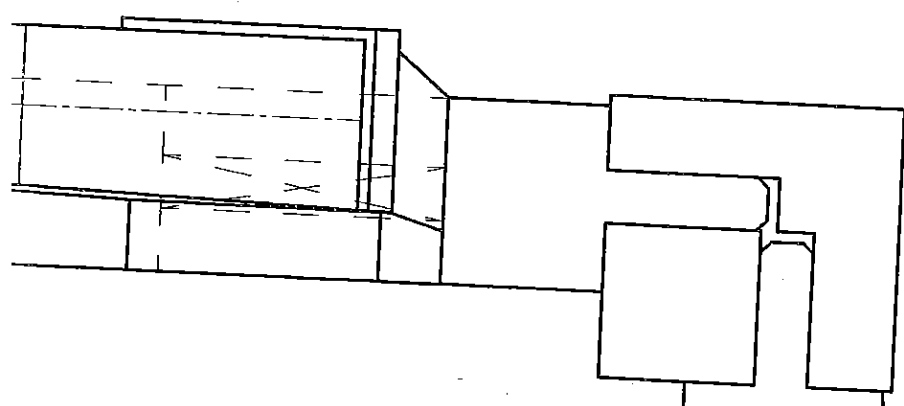

CRDP LORRAINE

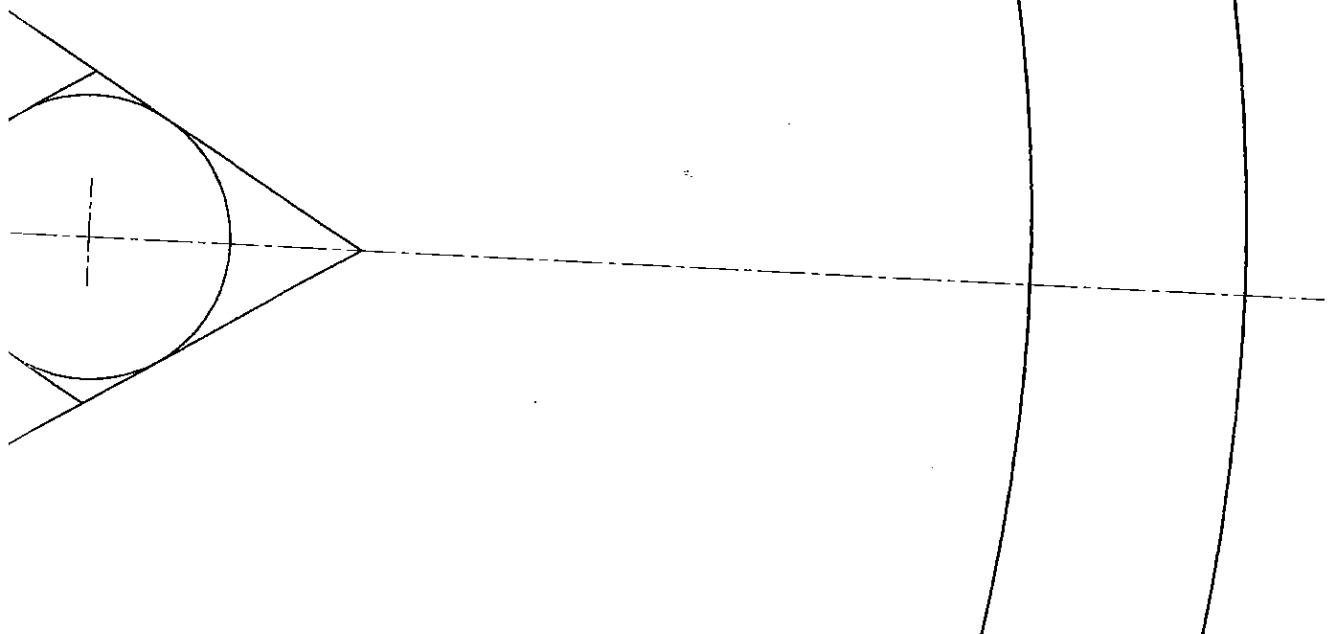

CAP DE MENUISIER	
EPREUVE : PRATIQUE D'ATELIER	DURE
SESSION 2009	REPE

CE PLAN EST EN 2 PA

CRDP LORRAINE

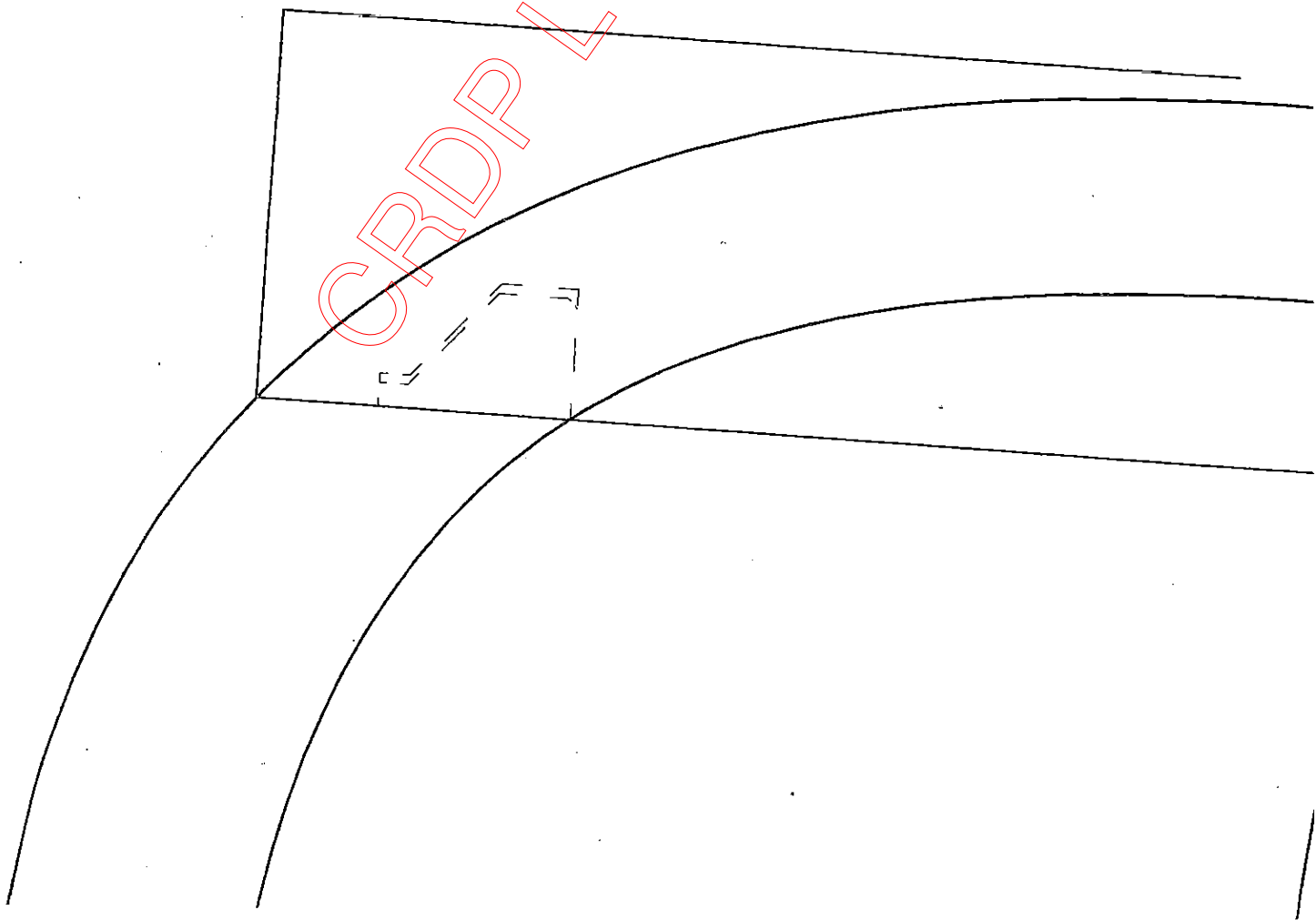

R EN SIÈGES	
# 24 H (TENONS) 20 H (TOURILLONS)	
RE : 5023411	PAGE 3/3

ARTIES 2/3 ET 3/3

RENVERS 96MM

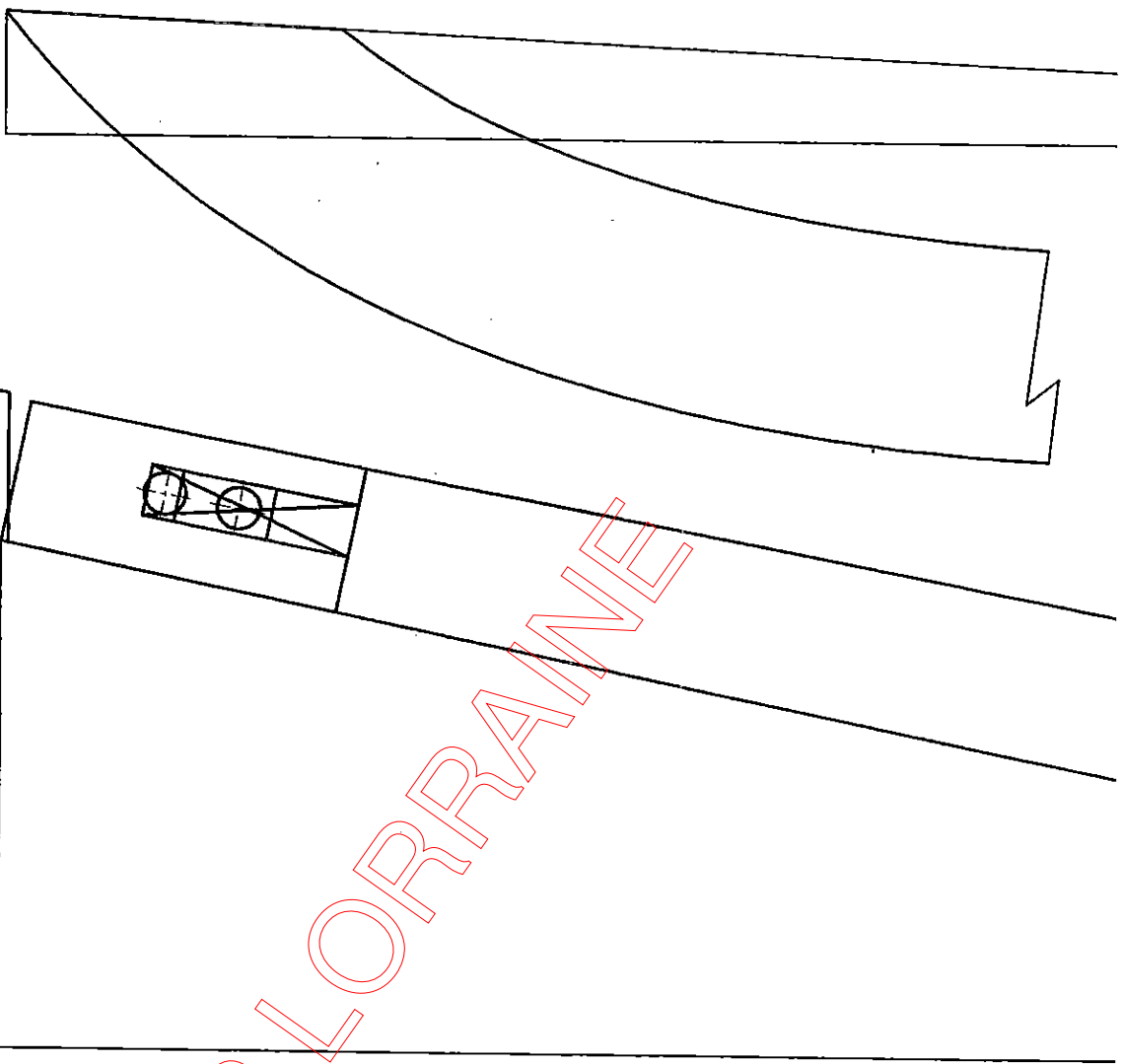

CRDP LORRAINE



TÉ

ET

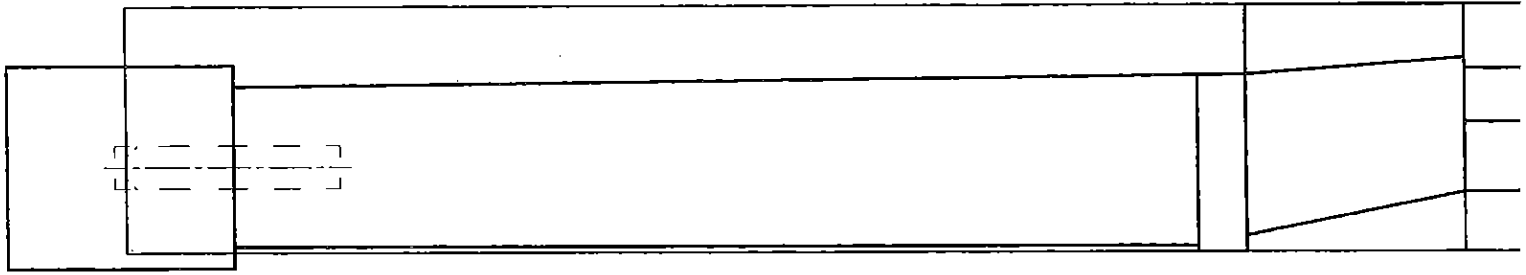
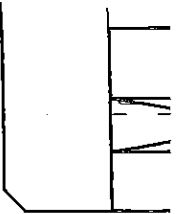

CRDP LORRAINE

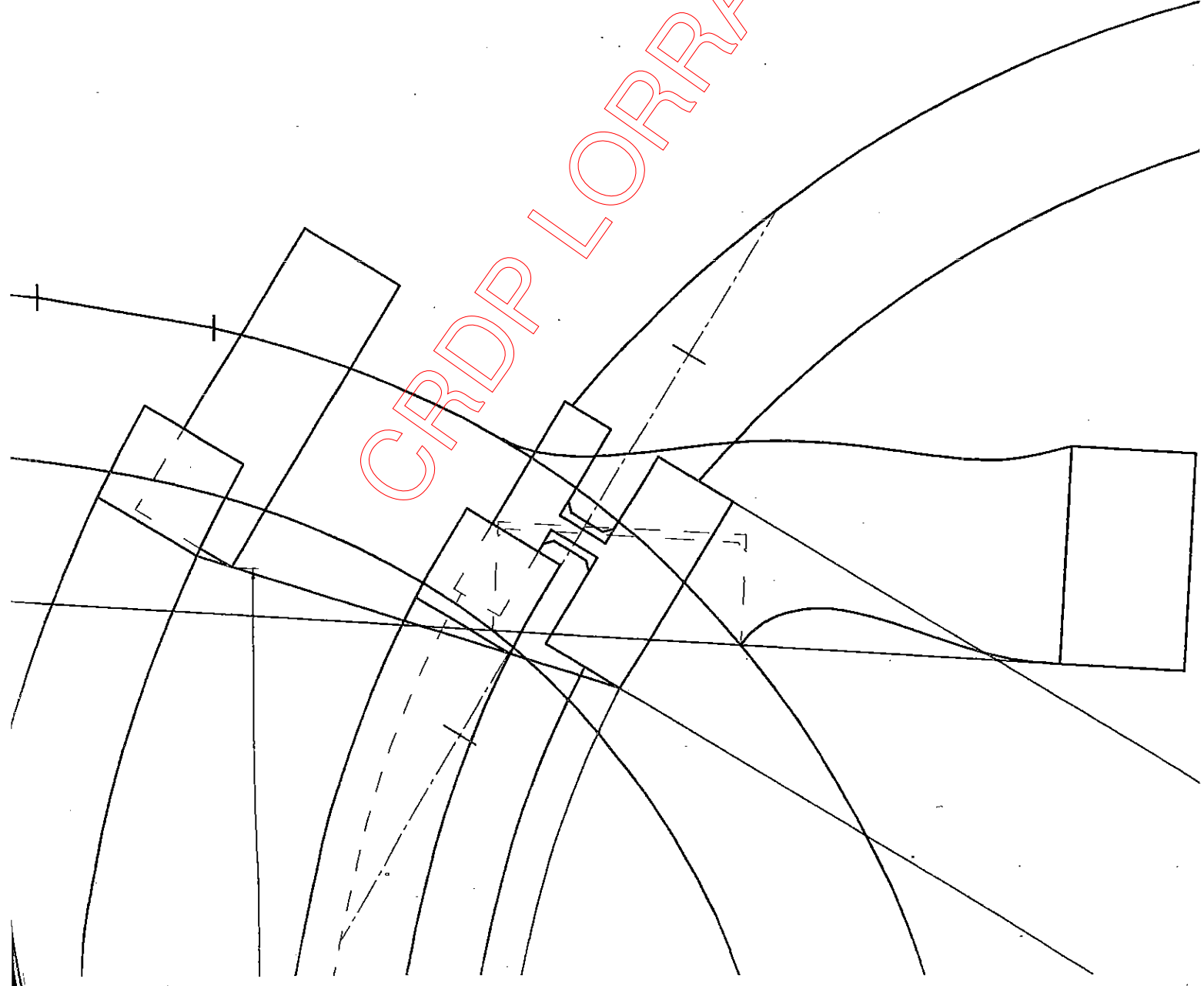

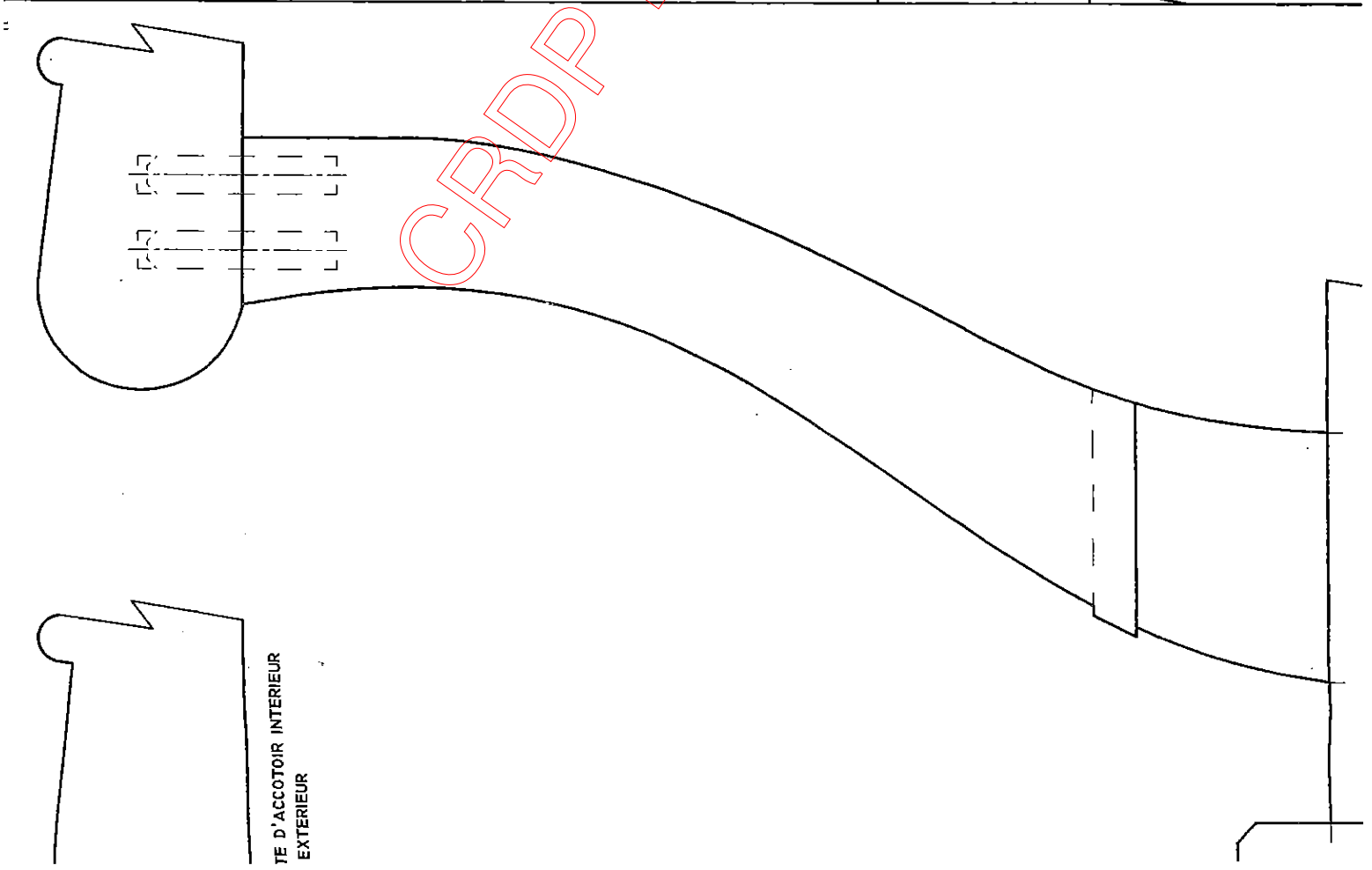
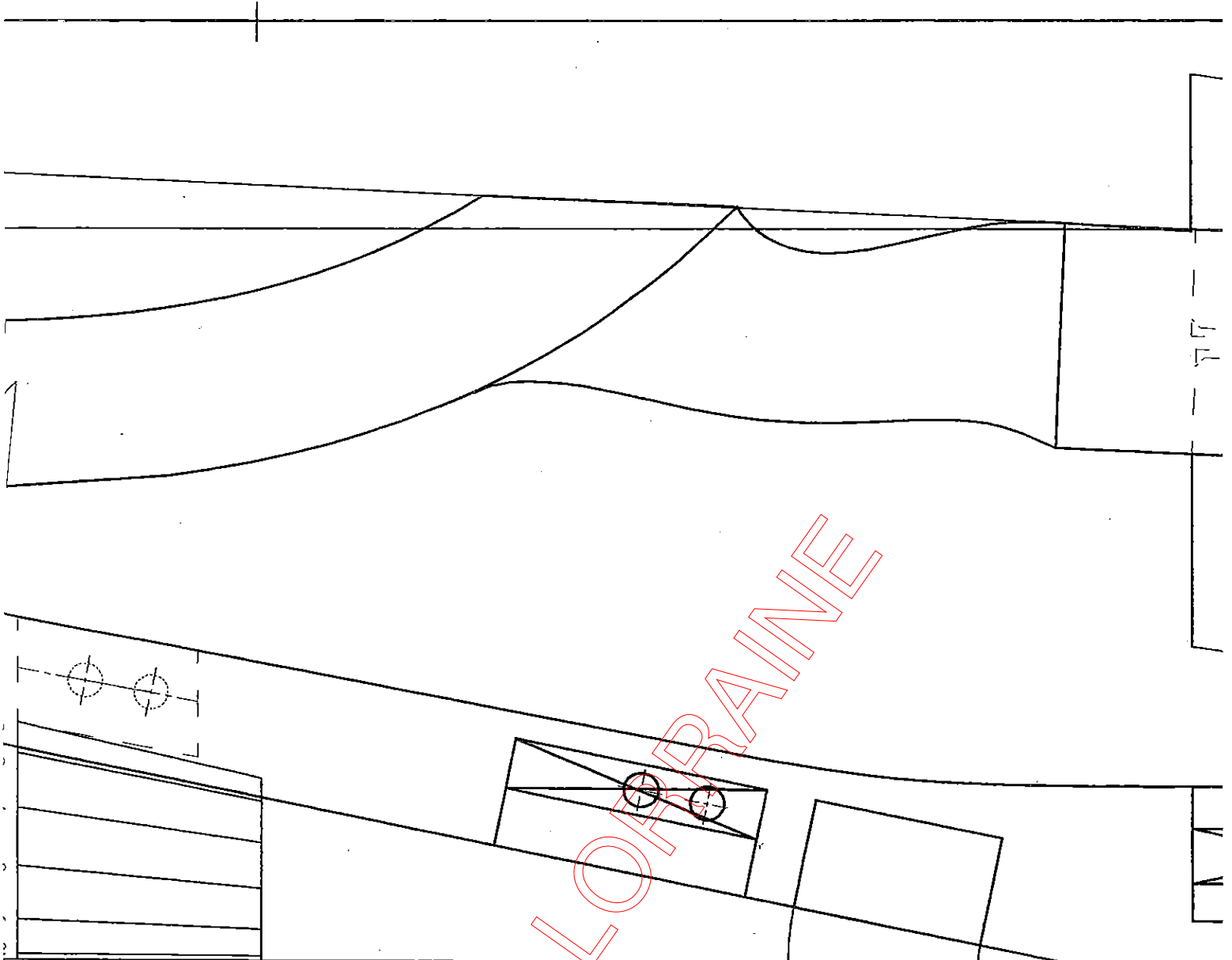

CRDP LORRAINE

TE D'ACCOTOIR INTERIEUR
EXTERIEUR

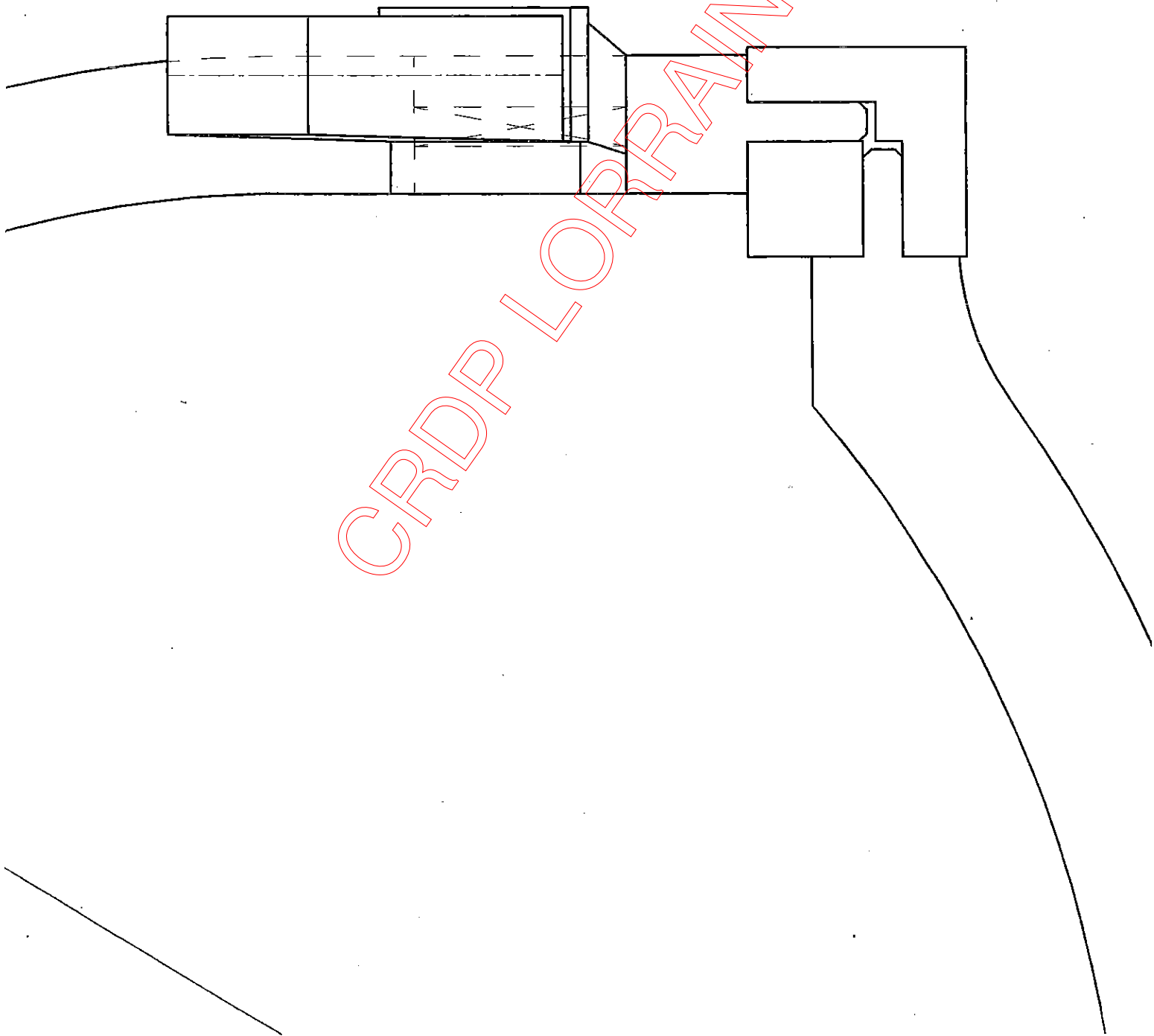
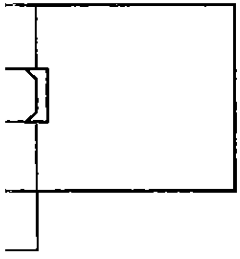
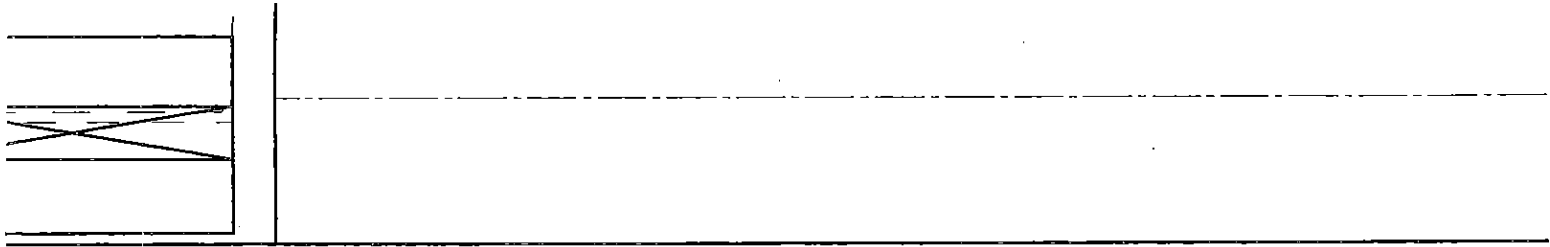

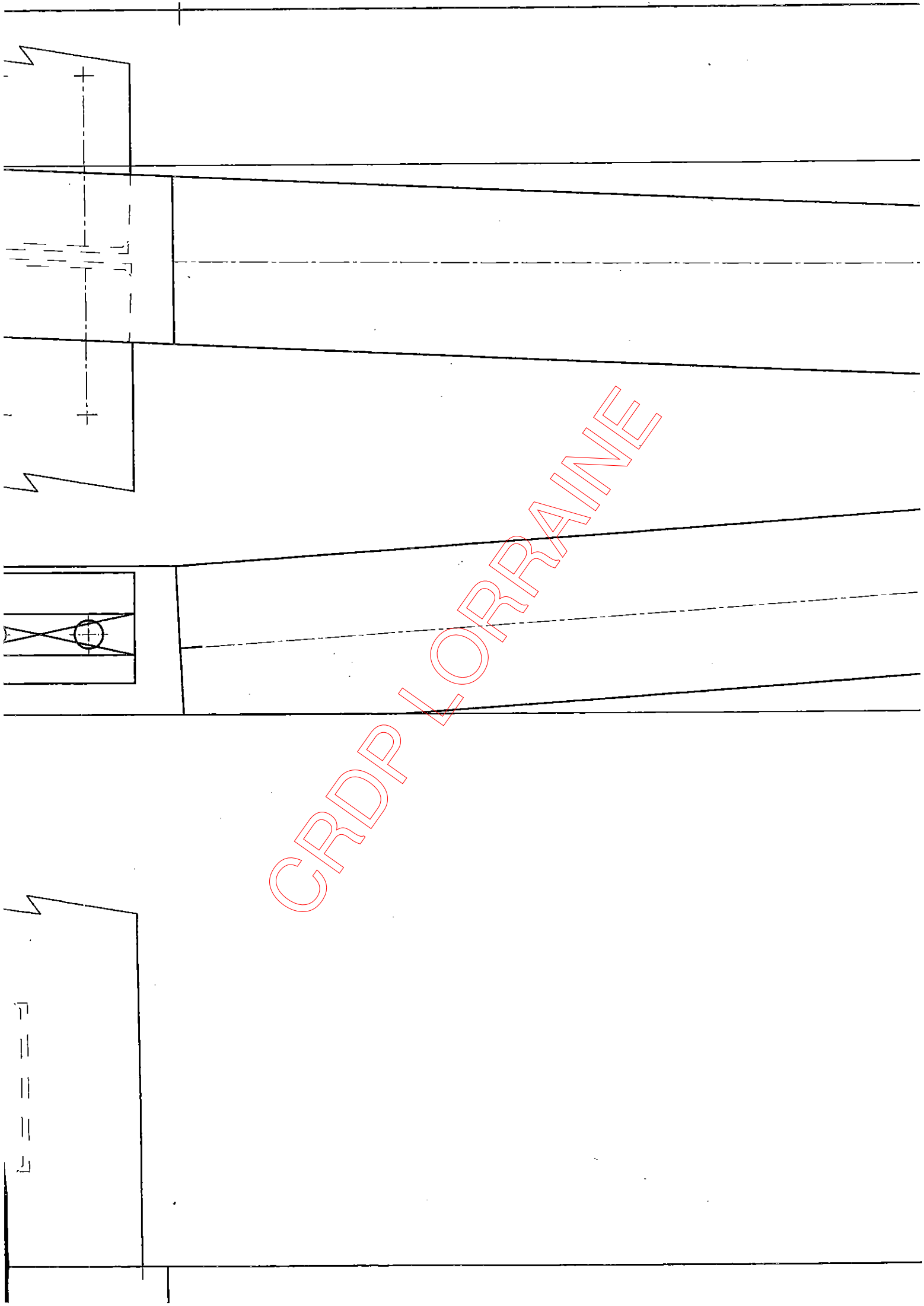

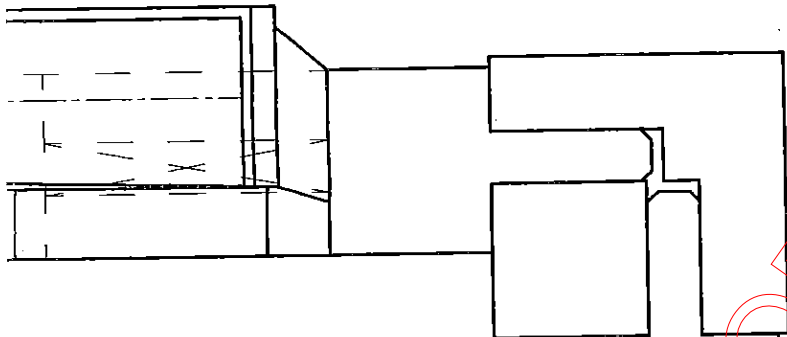
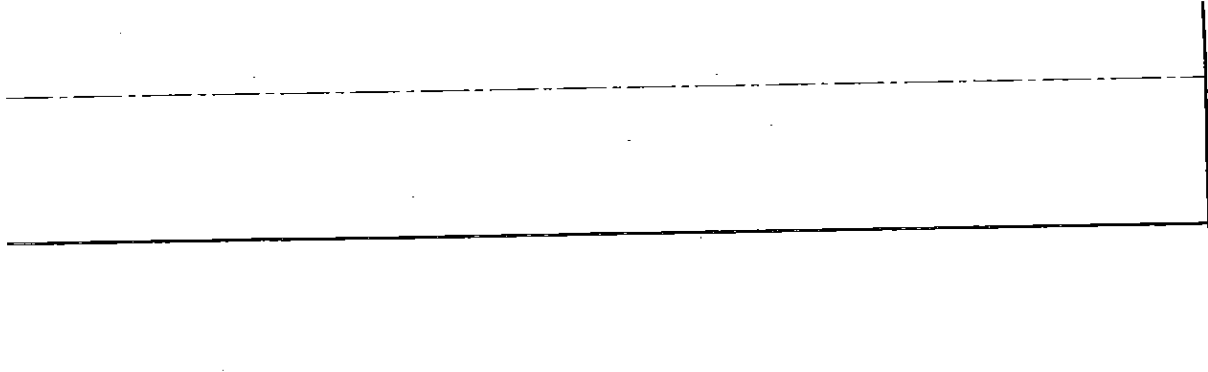

CRDP LORRAINE



CRDP LORRAINE